

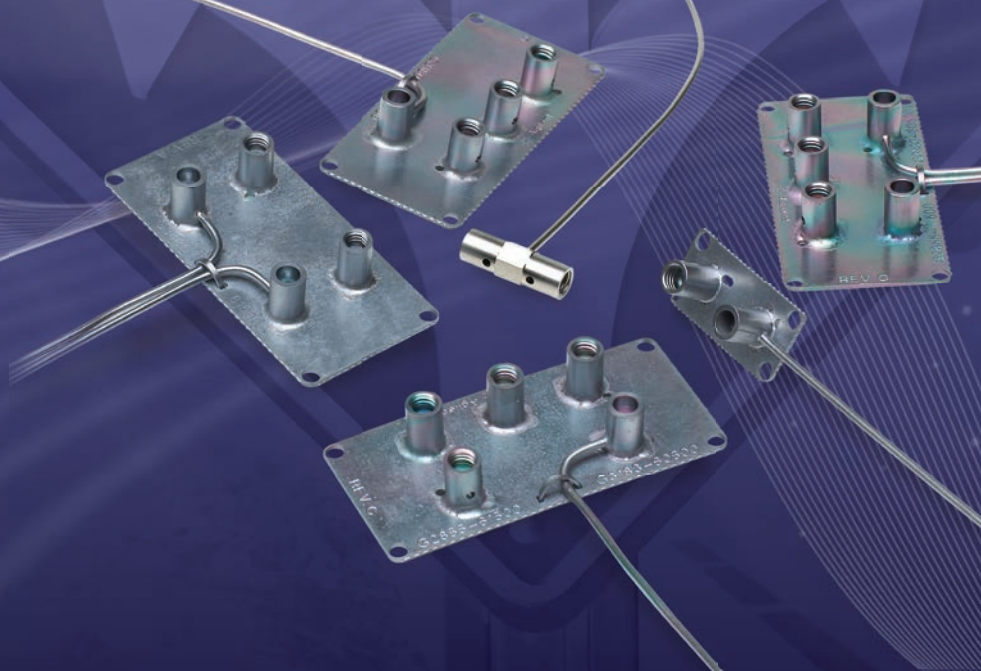

Capillary Flow Technology: Backflush

# REDUCE RUN TIME AND INCREASE LABORATORY THROUGHPUT

The Measure of Confidence



**Agilent Technologies**

# Increase productivity by dramatically reducing analytical run time

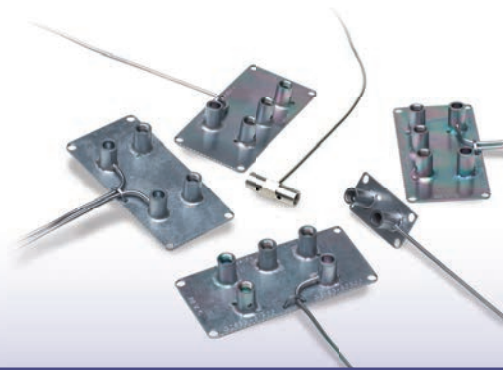

Many GC and GC/MS analyses are performed on complex samples that contain high-boiling compounds. Other methods may require detection and quantitation of peaks only found early in the chromatogram. In either case, analysis times are longer than necessary, because all components in the sample matrix must be fully eluted prior to starting the next run. This usually means including a bakeout routine at the end of the method that can add significantly to cycle times.

Agilent's Capillary Flow Technology modules provide a more efficient alternative. They enable the column to be backflushed once all peaks of interest have eluted. Backflushing reverses the flow in the column so that any remaining components are forced out through the sample inlet and offers many benefits, such as:

- » **Reduced cycle times.** Shorter analytical run times and cool-down times lead to faster results and higher laboratory throughput and productivity.
- » **Less maintenance.** Removing high boilers means less frequent column trimming and detector maintenance, as well as fewer recalibrations.
- » **Lower operating costs.** Columns last longer because they are not exposed to the higher temperatures needed for bakeout routines and there is no buildup of high boilers.
- » **Better data.** Column bleed is significantly reduced and ghost peaks are eliminated.

## Eliminate chromatographic problems

Typical backflush configurations employ traditional rotary valves, stainless-steel tubing, and fittings that have high thermal mass (so they do not track the oven temperature very well), are susceptible to leaks over time, and can cause peak broadening. Agilent's Capillary Flow Technology modules eliminate these chromatographic problems while allowing backflush to be performed quickly and easily.

- Low thermal mass allows the modules to closely follow the oven ramp
- Small, well-swept dead volumes eliminate peak broadening for better resolution
- Metal ferrules and fittings eliminate leaks – even after many oven temperature cycles – optimizing uptime and increasing the accuracy of results
- Deactivated surfaces exist throughout to prevent peak tailing or loss of analytes

Agilent CFT  
Dean's Switch



How it works...

## THE AGILENT CAPILLARY FLOW TECHNOLOGY BACKFLUSH MODULE

All Capillary Flow Technology modules require the use of an Electronic Pneumatic Control (EPC) module such as the Auxiliary EPC (AUX EPC) or the Pneumatic Control Module (PCM) to provide a second source of gas that directs the column flow to the appropriate column or detector. In normal operation, the Aux EPC or PCM pressure is slightly above the pressure of the carrier gas through the column. During backflush, the inlet pressure is dropped to 1 or 2 psi and the Aux EPC or PCM pressure is increased, thus reversing the flow through the analytical column and flushing unwanted matrix and residues out through the split vent.

Types of inlets amenable to backflush e.g., S/SL, MMI, PTV have replaceable split vent traps that are designed to handle whatever passes through the inlet – including backflushed high-boiling compounds. Because all sample components that have made it onto the column have passed through the inlet once, there is no problem when they pass through a second time.

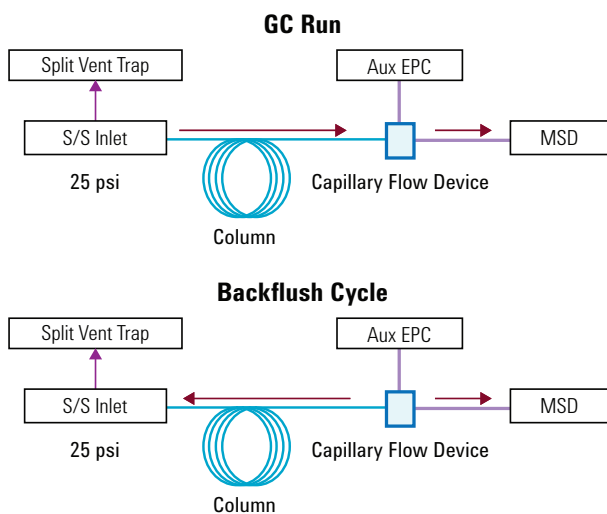

Agilent ChemStation software fully supports backflushing and other productivity enhancements enabled by Agilent Capillary Flow Technology.

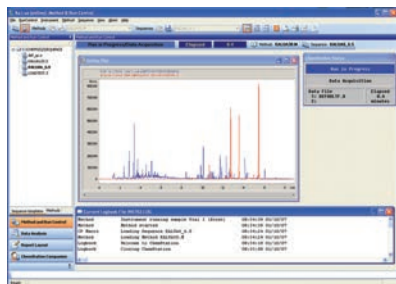

### Cut cycle time

**Figure 1** shows three total ion chromatograms from a milk extract analysis using an Agilent GC/MSD with a Capillary Flow Technology purged 3-way splitter. The top chromatogram shows that all the target compounds eluted before 42 minutes (oven program goes to 280 °C). However, an additional 33 minute bakeout period at 320 °C was needed to move the high boilers out of the column. This bakeout period was almost as long as the required time to elute all target compounds. The middle chromatogram depicts the same milk extract analysis stopped at 42 minutes with a 7 minute backflush post-run at 280 °C added to the analysis. The bottom chromatogram shows the results of a blank run, indicating a 7 minute backflush that cleaned the column, as well as a 33 minute bakeout.

This example illustrates the effectiveness of the backflush technique in reducing cycle time and sample carryover. The cycle time was reduced by more than 30% and the column did not have to be exposed to the higher bakeout temperature. Using backflush, excess column bleed and heavy residues are not introduced into the MSD, thereby reducing ion source contamination.

### Improving Productivity and Extending Column Life with Backflush

Agilent Application Note  
5989-6018EN

Industries:  
Multiple

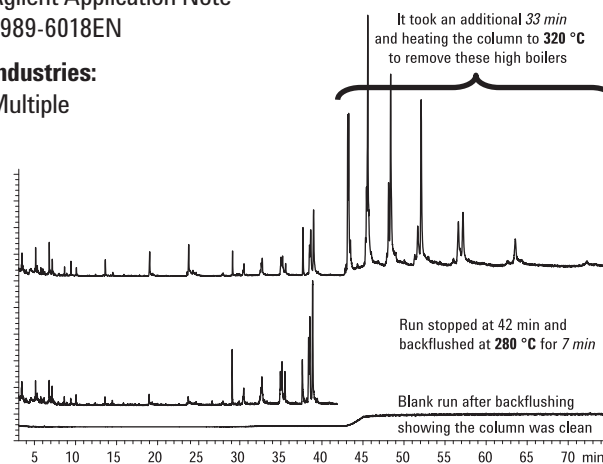

Figure 1. Backflushing reduces cycle time

To learn how you can increase productivity in your lab, visit [agilent.com/chem/CapillaryFlowTechnology](http://agilent.com/chem/CapillaryFlowTechnology)

## Eliminate sample carryover

Samples of fish oil spiked with Aroclors or individual PCB congeners were diluted and injected directly into an Agilent 7890 GC with dual ECDs and a Capillary Flow Technology Deans Switch, which was also used to backflush later eluting compounds. In this application, backflushing was employed to remove any remaining fish oil components that accumulate on the column and cause carryover and retention time shifts, even after a single run.

**Figure 2** shows a GC/FID chromatogram from a 1  $\mu$ L splitless injection of 10% fish oil using a 30 m x 0.18 mm x 0.18  $\mu$ m DB-XLB column. The arrow at approximately 17.5 minutes indicates where the GC/ECD method ends and the post-run

backflush begins. In this case, there was no backflushing so the oven was held at 290  $^{\circ}$ C for an extra 25 minutes. The run was repeated two more times without injection but with the oven held at 310  $^{\circ}$ C for 30 minutes at the end of the run. Residue from the fish oil injection continued to elute, even during a second bakeout step.

**Figure 3** shows the first (top) and sixth (inverted) injections of 10% fish oil spiked with Aroclor 1260. The column was backflushed after each run, preventing buildup of fish oil residue. The comparison shows that there was no shift in retention times caused by fish oil accumulation.

### Direct Injection of Fish Oil for the GC/ECD Analysis of PCBs

Agilent Application Note 5989-6095EN

#### Industries:

Environmental, Foods,  
Pharmaceuticals,  
Consumer Products

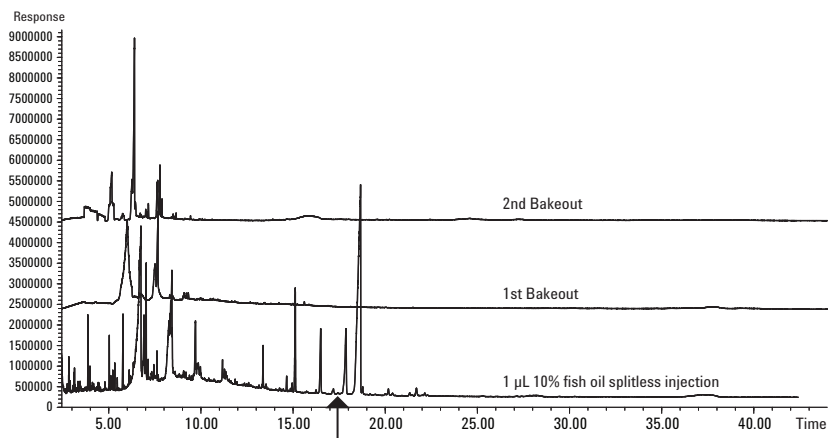

**Figure 2.** Carryover is still observed even after multiple bakeout runs

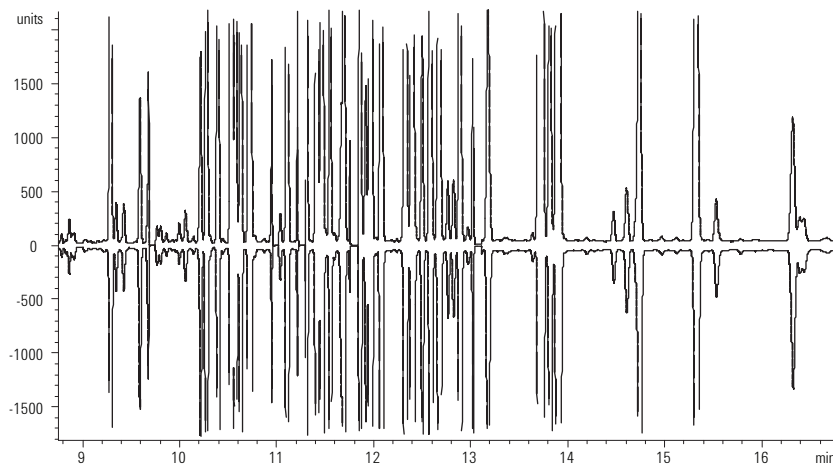

**Figure 3.** Backflush prevents buildup of fish oil residues, which eliminates sample carryover and retention time shifts

## Superior results faster

GC/MS analysis in samples extracted from heavy matrix, such as blood or other biological fluids, can be significantly impacted by matrix buildup in the source region which reduces sensitivity and increases the need for maintenance. Problems such as these commonly reduce laboratory productivity. In this example, the Purged Ultimate Union, commonly referred to as a pressure controlled tee (PCT), was used in a mid-point column configuration and post-run backflush mode to eradicate late eluting compounds.

**Figure 4** shows that even with the selective PCI and the most “gentle” CI reagent gas, the sample still is very complex and the analytes are diminutive compared to the other matrix components. Especially intense are the late-eluting biologicals,

which are known to “foul” the column phase. Removing these required the oven program to extend to 340 °C and remain there for 3 minutes. This process improved the chromatographic performance by restoring the column phase; but driving these components into the ion source rapidly degraded the analyte response. However, using the PCT configuration, these components were removed by backflushing them to the injection port and out the split vent.

This improvement is shown in **Figure 5**. Using a continuous 50 m column configuration (without PCT or backflush), the analyte signal continuously drops and by the thirtieth injection more than 30 percent of the original intensity has been lost. Using the PCT and employing backflushing maintains signal and remains within about 10 percent of the first injection’s response.

### Capillary Flow Technology for GC/MS: Efficacy of the Simple Tee Configuration for Robust Analysis Using Rapid Backflushing for Matrix Elimination

Agilent Application Note 5989-9359EN

**Industries:**  
Environmental

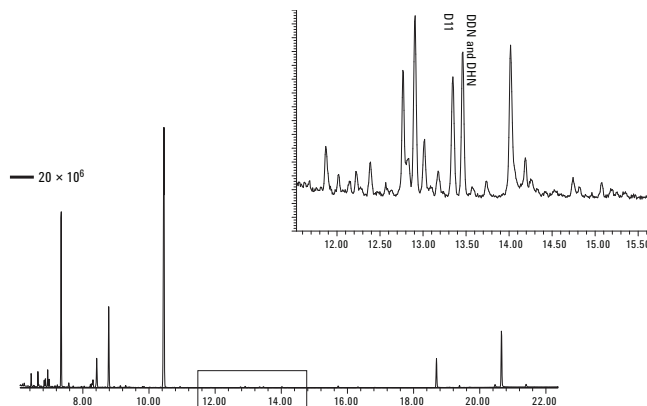

**Figure 2.** RTIC chromatogram of PCI-NH<sub>3</sub> full-scan acquisition of a typical sample. Note the intense, late-eluting (14 min.) components

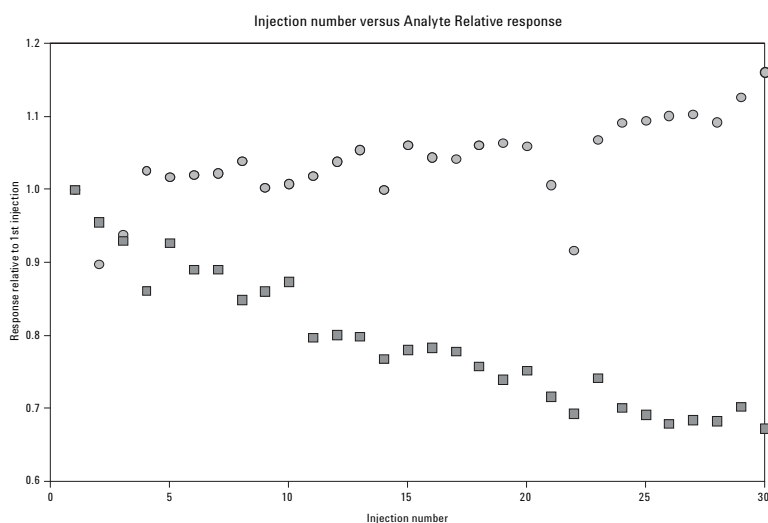

**Figure 3.** Analyte response versus injection number using the PCT with backflushing (circle) and using a continuous column without backflushing (squares)



## Maintain MSD sensitivity during backflush

Using Capillary Flow Technology devices requires the use of makeup gas, which introduces an additional flow in the sample stream. Because most modern GC detectors have more sensitivity than is needed for typical applications, this small dilution effect is of little concern, especially compared to the benefits realized by using Capillary Flow Technology. However, this must be considered when performing trace analyses using low flow rate detectors, such as an MSD.

A unique, alternative approach to backflushing is to use a Capillary Flow Technology device in the middle of the analytical column. In other words, instead of using a 30 m column, two 15 m columns are used and connected by a Capitalize Purged Ultimate Union (see **Figure 6**). The Aux EPC adds enough makeup gas to match that from the first column so there is very little flow addition (dilution) and subsequent decrease in sensitivity. Backflushing in this configuration is accomplished

by reducing the flow/pressure in the first column and increasing it in the second column. This configuration also allows column maintenance without venting the MSD. An added benefit is that it can be used with both turbo and diffusion pump MSD systems.

**Figure 7** shows an example of backflushing with the pressure-controlled tee configuration. The top chromatogram shows a six-standard chromatogram, where the third peak is considered the last analyte of interest and the fourth peak is the first of the late-eluting interferences. The middle chromatogram shows (a) the same standard with backflushing beginning at 10.1 minutes, where flow is dropped in the first 15 m column and (b) where the flow in the second column is increased. Note that the last analyte is retained but the late eluters never enter the MSD. The bottom chromatogram is a blank run, which shows no evidence of carryover.

### Capillary Flow Technology for GC/MS: a Simple Tee Configuration for Analysis at Trace Concentrations with Rapid Backflushing for Matrix Elimination

Agilent Application Notes  
5989-8664EN and 5989-9359EN

#### Industries:

Drug Testing, Environmental, Foods, Forensics, Metabolomics

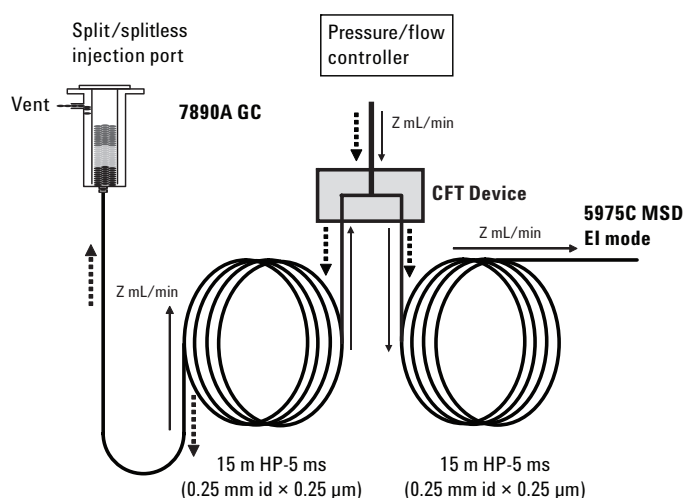

**Figure 6.** Schematic of pressure-controlled tee arrangement for the GC/MSD: solid lines indicate the forward flow during the analysis and dashed lines indicate the backflushing flows

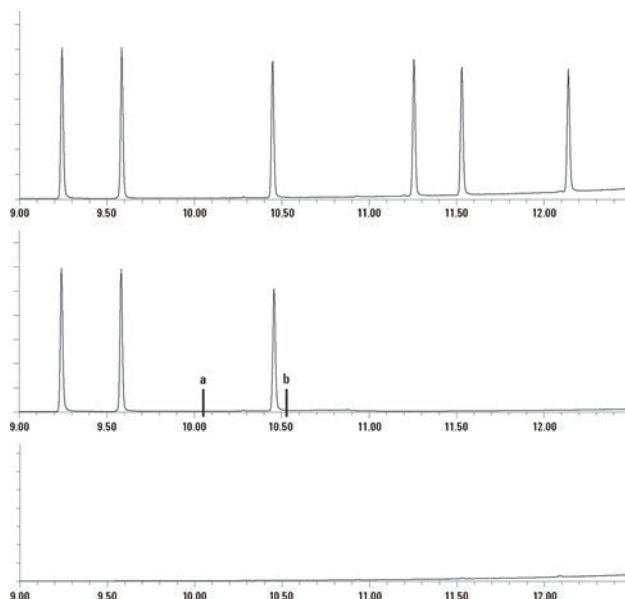

**Figure 7.** Backflushing with pressure-controlled tee configuration

## Elimination of ghost peaks, carryover, and baseline instability

GC/MS analysis of fragrances in cosmetics can suffer because of less volatile or non-volatile matrix components, such as detergents, waxes, lipids, etc. In this example, shampoo samples were directly injected, and a Capillary Flow Technology QuickSwap device was used to effectively backflush the low-volatility components.

**Without backflush.** The bottom chromatogram in figure 8 shows the sixth analysis of a shampoo extract, stopped at approximately 8 minutes (240 °C), after the last compound of interest had eluted. The middle chromatogram over the same time period shows the first blank run after the six runs; sample carryover is clearly evident as baseline disturbances and ghost peaks. There are other issues as well. The top chromatogram shows the second blank run extended to 320 °C where the

extent of highly-retained matrix peaks can clearly be seen. Over time, these can cause column deterioration, difficulty in detecting and quantifying minor sample components, reduced MS performance, and more frequent source cleaning.

**With backflush.** Figure 9 is an overlay of 10 consecutive analyses with backflush performed after each run, showing excellent retention time stability and peak area reproducibility – and no evidence of carryover, ghost peaks, or increasing baseline. An added benefit was a 20% run time reduction and faster oven recycle times.

### Suspected flavor and fragrance allergens in cosmetics

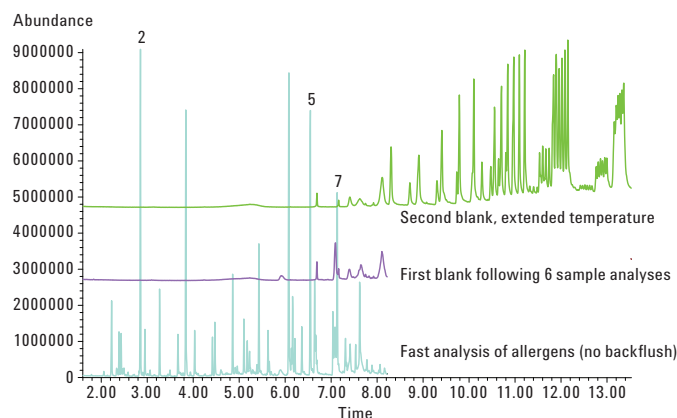

Figure 8. High-boiling sample components continue to elute in subsequent blank runs, especially at higher temperatures

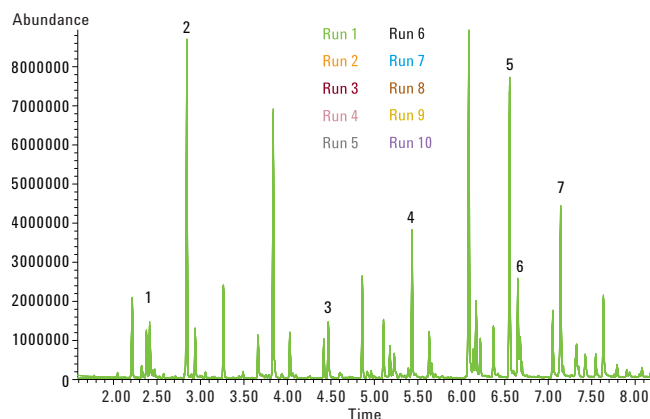

Figure 9. Overlay of ten consecutive analyses using backflush shows no evidence of ghost peaks due to sample carryover or column bleed

(An Agilent GC/MSD with Capillary Flow Technology QuikSwap module. See Agilent Application Note 5989-6460EN.)

To learn how you can increase productivity in your lab, visit [agilent.com/chem/CapillaryFlowTechnology](https://www.agilent.com/chem/CapillaryFlowTechnology)

## NEW BACKFLUSH WIZARD LETS YOU TAP THE FULL POWER OF BACKFLUSH



In a traditional GC or GC/MS system, the analytical run time is extended at the highest oven temperatures to elute unwanted components before making another injection. Due to the increased need for detector maintenance, this practice severely limits your laboratory's productivity.

The power of backflush is in the capability to achieve more analyses per unit time, shorter analysis cycle time and reduced requirement for sample preparation. To aid in the configuration and implementation of backflush on GC or GC/MS system, a new **Backflush Assistant Software Wizard** has been developed to:

- Guide the end-user to a proposed BF configuration
- Illustrate a step-by-step procedure to configure BF hardware/columns plumbing
- Develop and validate a backflush enabled method

### Easily set up backflush on your GC and GC/MS systems

The Backflush Wizard consists of two parts; a part that operates in Instrument Utilities and a part that operates as an Add-on application for the Data Acquisition System. The purpose of the Instrument Utilities part of the Backflush Wizard is to:

- Help the analyst decide which backflush technique to use
- Aid the analyst in setting up the necessary hardware
- Facilitate migration of RTL methods
- Assist in the setup of the backflush times for the selected and implemented technique

The Data System Add-on is necessary to set the timing for MS based systems and allows GC users to setup the backflush timing from the Data System.

The use of the Backflush Wizard is predicated on the analyst's desire to add backflush to a pre-existing method. The first step is completing the interview process, which allows you to create a template specific to your analysis. This helps you determine an approach to setting up backflush for optimized efficiency of your system. The series of questions provide a means to understand what may be the best backflush technique to use. Selection of the Capillary Flow Technology (CFT) device and information about the sample and method parameters will determine which technique should be used.



## BACKFLUSH WIZARD GUIDES YOU TO GREATER LAB PRODUCTIVITY

The wizard begins with a survey designed to learn about the analysts' current method and CFT device and provides a step-by-step procedure to configure the backflush hardware and column plumbing (**Figure 10**). Once the backflush method and timing has been determined by the automated tool, a validation protocol ensures the newly backflush enabled method is performing properly and robustly (**Figure 11**).



*Welcome to the Backflush Wizard*

setup

**Ready to create the backflush method?**

[Click here to begin](#)

Wizard Step	Progress	Completed
Watch Video	Not Started	---
Take Interview	Not Started	---
Flow Path Identification	Not Started	---
Column Modifications	Not Started	---
Setup Verification	Not Started	---
Select Last Peak of Interest	Not Started	---
Perform a Validation Run	Not Started	---
Perform a Blank Run	Not Started	---

**Backflush Utilities**

- [Watch Backflush Video \(English Only\)](#)
- [Take Backflush Interview](#)
- [Review Original Method](#)
- Review Backflush-Ready Method
- Review Backflushed Method

This instructional video provides an overview of what backflush is, the different configurations and their benefits, and the capillary flow devices you can use to set up backflush on your instrument.

[Back to process selection](#)

**Figure 10.** The Backflush Wizard provides a snapshot of your parameters at any given time. This makes it easy to create, configure, define and validate the most effective backflush method



**Figure 11.** Timing estimates are based on configuration and last peak of interest



Backflush Wizard enables you to easily select the most appropriate backflush technique to benefit from shorter run times and keeping your GC systems clean.

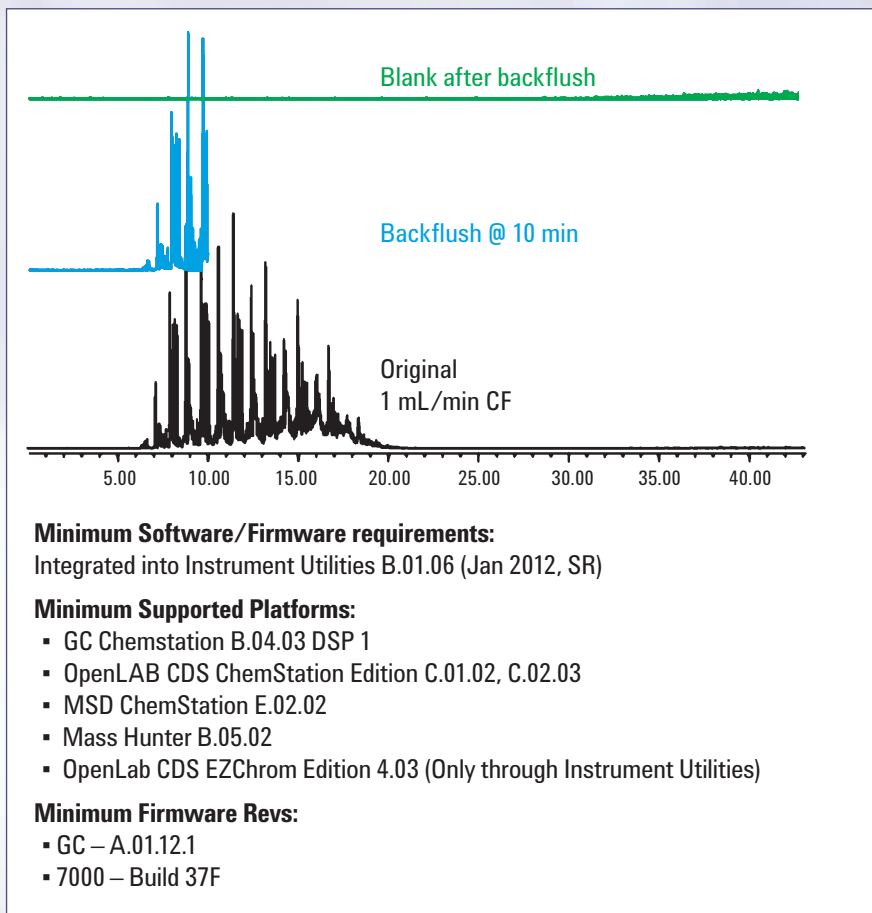

Figure 12. Shorten run time and keep GC system clean

### Here's what you need to take advantage of Agilent's Backflush Wizard

The following are requirements to use the Backflush Wizard.

- There must be a method to start from and preferably a data file. This must be a method that can be loaded and run to produce a reasonable chromatogram.
- The chromatograms must have 3 or greater well separated peaks.
- The GC must be a 7890 GC and have an inlet appropriate for backflush.
- The pressure source for the CFT device has to be physically installed and configured.
- For GC signals, the correct signal is selected as signal 1.

## HERE'S WHAT YOU NEED TO TAKE ADVANTAGE OF AGILENT'S BACKFLUSH TECHNOLOGY

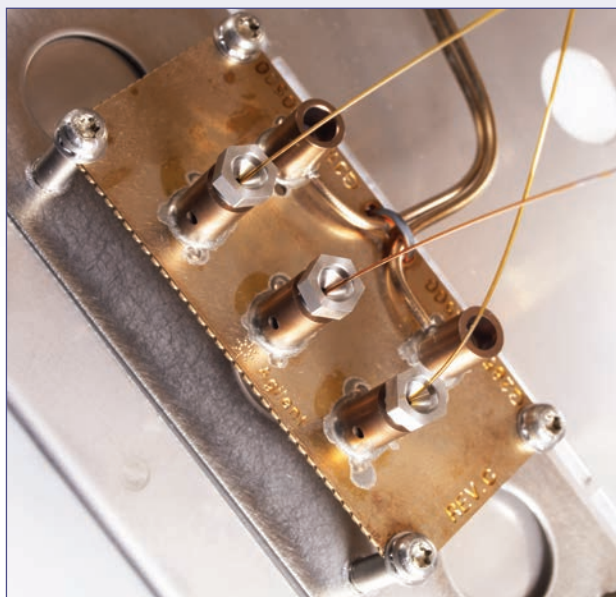

### An Agilent 7890 or 6890N GC with EPC

A Capillary Flow Technology device:

- Deans Switch
- Purged (2-way or 3-way) Splitter
- GCxGC Flow Modulator
- Purged Ultimate Union

### Flow source – Aux EPC module

- An Aux EPC Purge Regulator Kit is recommended for use with the Aux EPC module
- A PCM can be used in place of the Aux EPC, but is not recommended for this application

### High-temperature SiTite ferrules and fittings

Deactivated silica tubing for detector restrictor (for Deans Switch and splitters).

### CFT Backflush Training

Agilent Publication 5991-1471EN

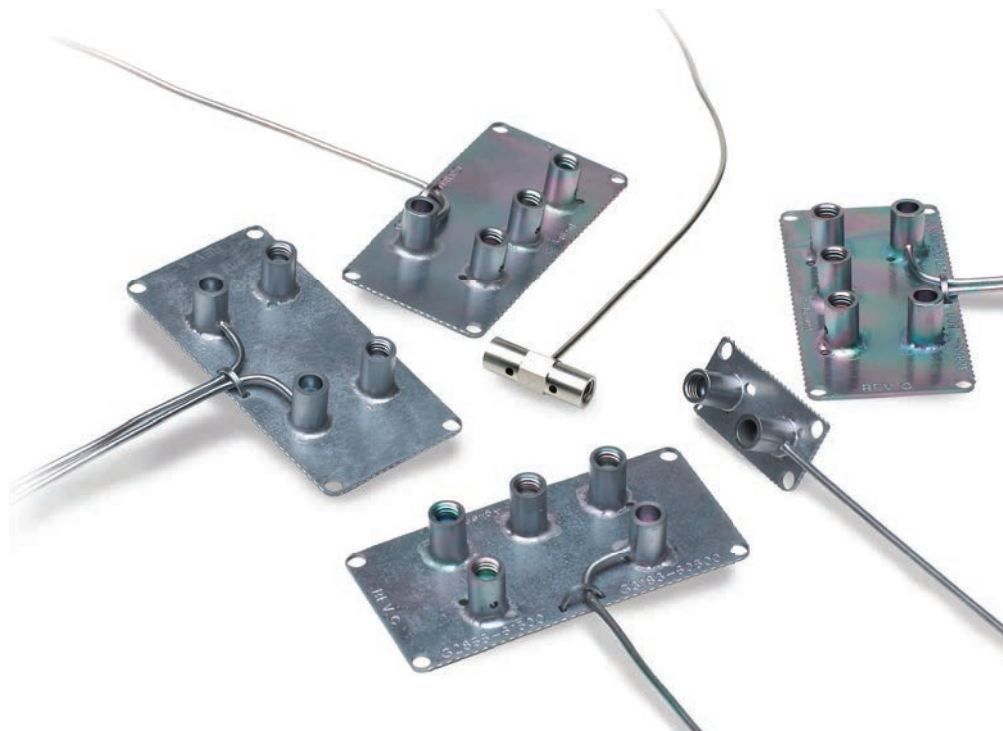

To learn how you can increase productivity in your lab, visit [agilent.com/chem/CapillaryFlowTechnology](http://agilent.com/chem/CapillaryFlowTechnology)

**A total portfolio of solutions from  
the leader in GC and GC/MS  
technology**



**When you buy instruments and systems from Agilent, you get more than just reliability**

You also get:

- **Over 40 years** of chromatography expertise and industry leadership.
- **Agilent J&W GC columns, calibration kits, mix cylinders, and filters** that conform to the industry's most stringent specifications, so you know they will deliver unbeatable precision, performance, and sensitivity.
- **Application solutions** that let you maintain stringent practices from sample preparation to analysis. So you can achieve rapid, reliable results that stand up to scrutiny.
- **Informatics software** for managing large quantities of data and preserving the integrity and security of your results.
- **World-class, global service and support** – on the Web, by phone or in person – that can save your lab time, optimize instrument use, and increase productivity.

**For more information**

Learn more about Agilent's Capillary Flow Technology at [agilent.com/chem/CapillaryFlowTechnology](http://agilent.com/chem/CapillaryFlowTechnology)

Buy online or find an Agilent customer center in your country:  
[agilent.com/chem/contactus](http://agilent.com/chem/contactus)

U.S. and Canada: **1-800-227-9770** or [agilent\\_inquiries@agilent.com](mailto:agilent_inquiries@agilent.com)

Europe: [info\\_agilent@agilent.com](mailto:info_agilent@agilent.com)

Asia Pacific: [adinquiry\\_aplsca@agilent.com](mailto:adinquiry_aplsca@agilent.com)

This information is subject to change without notice.

© Agilent Technologies, Inc. 2013  
Printed in the USA June 10, 2013  
5989-9804EN



**Agilent Technologies**