

Trolleys

Base trolleys and insert *for undercounter machines*

CS1-1 (art. 901696)

UPPER TROLLEY WITH SPRAYER

- suitable for holding of supports and baskets
- usable area LxD: 460 x 450 mm
- usable height adjustable on two positions: 190 mm or 240 mm
- made of stainless steel



Machines

GW0260-00-00J	GW0260-S0-00J	GW1260-00-000	GW1260-S0-000	GW1260-SC-000
GW3060BX	GW3060BXA	GW3060BXC	GW3060BXCA	GW3060P
GW3060PA	GW3060S	GW3060SA	GW3060SC	GW3060SCA
GW4060	GW4060A	GW4060C	GW4060CA	GW4060S
GW4060SA	GW4060SC	GW4060SCA	GW4090	GW4090A
GW4090BXC	GW4090BXCA	GW4090BXP	GW4090C	GW4090CA
GW4090P	GW4090PA	GW4260-00-000	GW4260-S0-000	GW4260-S0-060
GW4260-SC-000	GW4290-00-000	GW4290-SC-000		

CS2 (art. 900032)

LOWER TROLLEY

- suitable for holding of supports and baskets
- usable area LxD: 480 x 500 mm
- usable height: 230 mm
- made of stainless steel



Machines

GW0260-00-00J	GW0260-S0-00J	GW1260-00-000	GW1260-S0-000	GW1260-SC-000
GW3060BX	GW3060BXA	GW3060BXC	GW3060BXCA	GW3060P
GW3060PA	GW3060S	GW3060SA	GW3060SC	GW3060SCA
GW4060	GW4060A	GW4060C	GW4060CA	GW4060S
GW4060SA	GW4060SC	GW4060SCA	GW4090	GW4090A
GW4090BXC	GW4090BXCA	GW4090BXP	GW4090C	GW4090CA
GW4090P	GW4090PA	GW4260-00-000	GW4260-S0-000	GW4260-S0-060
GW4260-SC-000	GW4290-00-000	GW4290-SC-000		

D-CS1 (art. 901204)

UPPER TROLLEY WITH SPRAYER 45CM

- suitable for holding of supports and baskets
- usable area LxD: 310 x 430 mm
- usable height: 250 mm
- made of stainless steel



Machines

GW1245-S0-100

D-CS2 (art. 901205)

LOWER TROLLEY 45 CM

- suitable for holding of supports and baskets
- usable area LxD: 330 x 450 mm
- usable height: 250 mm
- made of stainless steel



Machines

GW1245-S0-100

M-CS1DUO (art. 905225)

"HALF SPACE" UPPER TROLLEY WITH DOUBLE SPRAYER

- suitable for positioning supports and baskets
- equipped with manifold with two spray arms
- versionable by means of an appropriate accessory, included, in order to be coupled to lower trolleys, both spraying or injection
- useful surface WxD: 460 x 310 mm
- made of stainless steel

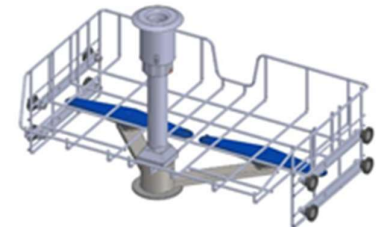

Machines

GW0260-00-00J	GW0260-S0-00J	GW1260-00-000	GW1260-S0-000	GW1260-SC-000
GW3060BX	GW3060BXA	GW3060BXC	GW3060P	GW3060PA
GW3060S	GW3060SA	GW3060SC	GW3060SCA	

M-CS1DUODS (art. 905226)

"HALF SPACE" UPPER TROLLEY WITH DOUBLE SPRAYER AND DRYING SYSTEM CONNECTION

- suitable for positioning supports and baskets
- equipped with manifold with two spray arms
- versionable by means of an appropriate accessory, included, in order to be coupled to lower trolleys, both spraying or injection
- useful surface WxD: 460 x 310 mm
- made of stainless steel

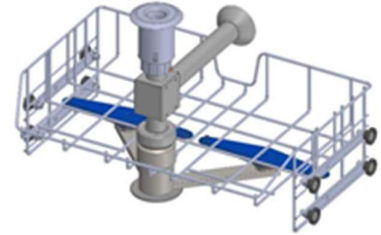

Machines

GW4090	GW4090A	GW4090BXC	GW4090BXCA	GW4090BXP
GW4090C	GW4090CA	GW4090P	GW4090PA	GW4260-00-000
GW4260-S0-000	GW4260-SC-000	GW4290-00-000	GW4290-SC-000	

Narrow neck glassware injection trolleys *for undercounter machines*

LB16 (art. 900606)

LOWER INJECTION TROLLEY FOR BOTTLES

- suitable for washing 16 glassware pieces
- narrow-neck bottles wide 250-1000 ml with dim. max. diam. 101 mm - h 450 mm
- graduated cylinders (diam. max 101mm - h 495mm)
- equipped with the following nozzles: 16 x U6170 (170 mm)
- positioned on the lower level
- made of stainless steel



Machines

GW0260-00-00J	GW0260-S0-00J	GW1260-00-000	GW1260-S0-000	GW1260-SC-000
GW3060BX	GW3060BXA	GW3060BXC	GW3060P	GW3060PA
GW3060S	GW3060SA	GW3060SC	GW3060SCA	

LB16DS (art. 900604)

LOWER INJECTION TROLLEY FOR BOTTLES WITH DRYING SYSTEM

- suitable for washing 16 glassware pieces
- narrow-neck bottles / wide 250-1000 ml with max. diam. 101 mm - h 450 mm
- graduated cylinders (diam. max. 101 mm - h 495 mm)
- equipped with the following nozzles: 16 x U6170 (170 mm)
- positioned on the lower level
- made of stainless steel



Machines

GW4090	GW4090A	GW4090BXC	GW4090BXCA	GW4090BXP
GW4090C	GW4090CA	GW4090P	GW4090PA	GW4260-00-000
GW4260-S0-000	GW4260-SC-000	GW4290-00-000	GW4290-SC-000	

LB16DSBX (art. 904631)

LOWER INJECTION TROLLEY WITH DRYING SYSTEM

- It can be equipped with a maximum of 16 injectors, even different from each other, for washing glassware of various sizes (maximum dimensions diameter 101 mm, h 495 mm)
- compose the insert with the desired nozzles (the uncovered positions must be closed by a cap code TAPPOUG)
- equipped with perimeter frame and central grid for better stability of the glassware
- equipped with bottom net with 10 x 10 mm mesh
- positioning on a lower level
- made of stainless steel
- for nozzle configuration consult the Area Manager



Machines

GW4090	GW4090A	GW4090BXC	GW4090BXCA	GW4090BXP
GW4090C	GW4090CA	GW4090P	GW4090PA	GW4260-00-000
GW4260-S0-000	GW4260-SC-000	GW4290-00-000	GW4290-SC-000	

LB16I (art. 900605)

LOWER INJECTION TROLLEY FOR BOTTLES

- suitable for washing 16 narrow-neck bottles / wide with max. diam. 101 mm - h 200 mm
- possible to wash different kind of glassware compatible with the max allowable dimensions
- equipped with the following nozzles: 16 x U6170 (170 mm)
- positioned on the lower level
- to combine to a injection trolley on the upper level
- made of stainless steel



Machines

GW0260-00-00J	GW0260-S0-00J	GW1260-00-000	GW1260-S0-000	GW1260-SC-000
GW3060BX	GW3060BXA	GW3060BXC	GW3060P	GW3060PA
GW3060S	GW3060SA	GW3060SC	GW3060SCA	

LB16S (art. 900607)

UPPER INJECTION TROLLEY FOR BOTTLES

- suitable for washing 16 narrow-neck bottles / wide (diam. max 101 mm - h 200 mm)
- possible to wash different glassware compatible with the max allowable dimensions
- equipped with the following nozzles: 16 x U6170 (170 mm)
- positioned on the upper level
- to be coupled with an injection rack on the lower level
- made of stainless steel



Machines

GW0260-00-00J	GW0260-S0-00J	GW1260-00-000	GW1260-S0-000	GW1260-SC-000
GW3060BX	GW3060BXA	GW3060BXC	GW3060P	GW3060PA
GW3060S	GW3060SA	GW3060SC	GW3060SCA	

LB16S-DS (art. 900603)

UPPER INJECTION TROLLEY FOR BOTTLES WITH DRYING SYSTEM

- suitable for washing and drying 16 narrow-neck bottles / wide (diam. max 101 mm - h 200 mm)
- possible to wash other kind of glassware compatible with the max dimensions
- equipped with 16 x U6170 (170 mm) nozzles
- positioned on the upper level
- to combine with the lower level injection trolley
- provided of drying system connector
- made of stainless steel



Machines

GW4090	GW4090A	GW4090BXC	GW4090BXCA	GW4090BXP
GW4090C	GW4090CA	GW4090P	GW4090PA	GW4260-00-000
GW4260-S0-000	GW4260-SC-000	GW4290-00-000	GW4290-SC-000	

LB32 (art. 900394)

TWO LEVEL INJECTION TROLLEY FOR BOTTLES

- suitable for washing 32 narrow-neck bottles / wide 250-1000 ml (diam. max 101 mm - h 230 mm)
- equipped with the following nozzles: 32 x U6170 (170 mm)
- positioned on 2 levels
- made of stainless steel



Machines

GW0260-00-00J	GW0260-S0-00J	GW1260-00-000	GW1260-S0-000	GW1260-SC-000
GW3060BX	GW3060BXA	GW3060BXC	GW3060P	GW3060PA
GW3060S	GW3060SA	GW3060SC	GW3060SCA	

LB32DS (art. 900395)

TWO LEVEL INJECTION TROLLEY FOR BOTTLES WITH DRYING SYSTEM

- suitable for washing and drying 32 narrow-neck bottles / wide 250-1000 ml (diam. max 101 mm - h 230 mm)
- equipped with the following nozzles: 32 x U6170 (170 mm)
- positioned on 2 levels
- made of stainless



Machines

GW4090	GW4090A	GW4090BXC	GW4090BXCA	GW4090BXP
GW4090C	GW4090CA	GW4090P	GW4090PA	GW4260-00-000
GW4260-S0-000	GW4260-SC-000	GW4290-00-000	GW4290-SC-000	

LB40 (art. 900566)

TROLLEY FOR BUTYROMETERS

- suitable for washing 40 butyrometers
- specify the type of butyrometers when ordering
- positioned on the lower level
- made of stainless steel



Machines

GW0260-00-00J	GW0260-S0-00J	GW1260-00-000	GW1260-S0-000	GW1260-SC-000
GW3060BX	GW3060BXA	GW3060BXC	GW3060P	GW3060PA
GW3060S	GW3060SA	GW3060SC	GW3060SCA	

LB40DS (art. 900567)

TROLLEY FOR BUTYROMETERS WITH DRYING SYSTEM

- suitable for washing and drying 40 butyrometers
- specify the type of butyrometers when ordering
- positioned on the lower level
- made of stainless steel



Machines

GW4090	GW4090A	GW4090BXC	GW4090BXCA	GW4090BXP
GW4090C	GW4090CA	GW4090P	GW4090PA	GW4260-00-000
GW4260-S0-000	GW4260-SC-000	GW4290-00-000	GW4290-SC-000	

LB4B (art. 903669)

TROLLEY FOR LARGE BOTTLES

- suitable for washing 4 x 10 liters bottles (d 227 x h 410 mm) or 4 x 5 liters bottles (d 182 x h 330 mm)
- suitable for washing 4 x 5 liters Erlenmeyer flasks
- equipped with the following nozzles: 4 x special
- positioned on the lower level
- made of stainless steel



Machines

GW0260-00-00J	GW0260-S0-00J	GW1260-00-000	GW1260-S0-000	GW1260-SC-000
GW3060BX	GW3060BXA	GW3060BXC	GW3060P	GW3060PA
GW3060S	GW3060SA	GW3060SC	GW3060SCA	

LB4BDS (art. 903670)

TROLLEY FOR LARGE BOTTLES

- suitable for washing 4 x 10 liters bottles (d 227 x h 410mm) or 4 x 5 liters bottles (d 182 x h 330 mm)
- suitable for washing 4 x 5 liters Erlenmeyer flasks
- equipped with 4 special nozzles
- positioned on the lower level
- made of stainless steel



Machines

GW4090	GW4090A	GW4090BXC	GW4090BXCA	GW4090BXP
GW4090C	GW4090CA	GW4090P	GW4090PA	GW4260-00-000
GW4260-S0-000	GW4260-SC-000	GW4290-00-000	GW4290-SC-000	

LB8 (art. 900236)

TROLLEY FOR LARGE DIMENSION GLASSWARE

- suitable for washing 8 large bottles max diam. 160mm max height 50 cm
- equipped with the following nozzles: 8 x U6260 (260 mm), 8 x special nozzles
- positioned on the lower level
- made of stainless steel



Machines

GW0260-00-00J	GW0260-S0-00J	GW1260-00-000	GW1260-S0-000	GW1260-SC-000
GW3060BX	GW3060BXA	GW3060BXC	GW3060P	GW3060PA
GW3060S	GW3060SA	GW3060SC	GW3060SCA	

LB8DS (art. 900363)

TROLLEY FOR LARGE BOTTLES WITH DRYING SYSTEM

- suitable for washing and drying 8 large bottles max height 50 cm
- equipped with the following nozzles: 8 x U6260 (260 mm), 8 x U6310 (310 mm)
- positioned on the lower level
- made of stainless steel



Machines

GW4090	GW4090A	GW4090BXC	GW4090BXCA	GW4090BXP
GW4090C	GW4090CA	GW4090P	GW4090PA	GW4260-00-000
GW4260-S0-000	GW4260-SC-000	GW4290-00-000	GW4290-SC-000	

LBT4DS (art. 902307)

TROLLEY FOR Erlenmeyer FLASKS OF 5L WITH DRYING SYSTEM

- suitable for washing 4 x 5 liters Erlenmeyer flasks
- equipped with the following nozzles: 4 x special
- positioned on the lower level
- made of stainless steel



Machines

GW4090	GW4090A	GW4090BXC	GW4090BXCA	GW4090BXP
GW4090C	GW4090CA	GW4090P	GW4090PA	GW4260-00-000
GW4260-S0-000	GW4260-SC-000	GW4290-00-000	GW4290-SC-000	

LBT5 (art. 901086)

TROLLEY FOR BOTTLES

- suitable for washing 5 x 5 liters bottles (d 182 x h 500mm, d. neck max 80 mm)
- equipped with the following nozzles: 5 x special nozzles
- positioned on the lower level
- made of stainless steel



Machines

GW0260-00-00J	GW0260-S0-00J	GW1260-00-000	GW1260-S0-000	GW1260-SC-000
GW3060BX	GW3060BXA	GW3060BXC	GW3060P	GW3060PA
GW3060S	GW3060SA	GW3060SC	GW3060SCA	

LBT5DS (art. 901085)

TROLLEY FOR BOTTLES WITH DRYING SYSTEM

- suitable for washing and drying 5 x 5 liters bottles (d 182 x h 500 mm, d. neck max 80 mm)
- equipped with the following nozzles: 5 x special nozzles
- positioned on the lower level
- made of stainless steel



Machines

GW4090	GW4090A	GW4090BXC	GW4090BXCA	GW4090BXP
GW4090C	GW4090CA	GW4090P	GW4090PA	GW4260-00-000
GW4260-S0-000	GW4260-SC-000	GW4290-00-000	GW4290-SC-000	

LM20 (art. 900234)

UNIVERSAL FLASK WASHING - 20 POSITIONS

- suitable for washing narrow-necked glassware up to 490 mm in height
- equipped with the following nozzles: 2 x U6260 (260 mm), 2 x U6240 (240 mm), 2 x U6220 (220 mm), 3 x U4180 (180 mm), 2 x U4160 (160 mm), 2 x U4140 (140 mm), 3 x U3110 (110 mm), 4 x U390 (90 mm), 1 x UC6 (curved)
- half trolley for free loading, to be completed with test tube baskets, Erlenmeyer flask supports, basket CSK2
- positioned on the lower level
- made of stainless steel



Machines

GW0260-00-00J	GW0260-S0-00J	GW1260-00-000	GW1260-S0-000	GW1260-SC-000
GW3060BX	GW3060BXA	GW3060BXC	GW3060P	GW3060PA
GW3060S	GW3060SA	GW3060SC	GW3060SCA	

LM20BX (art. 903979)

FLEXIBLE FLASK WASHING - 20 POSITIONS

- suitable for washing narrow-necked glassware up to 490mm in height
- 20 positions rack without nozzles
- to be equipped with 20 nozzles (unused positions must be covered with caps cod. TAPPOUG)
- half trolley for free loading, to be completed with test tube baskets, Erlenmeyer flask supports, basket CSK2
- positioned on the lower level
- made of stainless steel
- for nozzles configuration consult your Area Manager



Machines

GW0260-00-00J	GW0260-S0-00J	GW1260-00-000	GW1260-S0-000	GW1260-SC-000
GW3060BX	GW3060BXA	GW3060BXC	GW3060P	GW3060PA

LM20BXDS (art. 903980)

FLEXIBLE FLASK WASHING WITH DRYING SYSTEM - 20 POSITIONS

- suitable for washing narrow-necked glassware up to 490mm in height
- 20 positions rack without nozzles
- to be equipped with 20 nozzles (unused positions must be covered with caps cod. TAPPOUG)
- half load rack to be arranged with test tubes support, flasks support, CSK2 basket
- positioned on the lower level
- made of stainless steel
- for nozzles configuration consult your Area Manager



Machines

GW4090	GW4090A	GW4090BXC	GW4090BXCA	GW4090BXP
GW4090C	GW4090CA	GW4090P	GW4090PA	GW4260-00-000
GW4260-S0-000	GW4260-SC-000	GW4290-00-000	GW4290-SC-000	

LM20DS (art. 900235)

UNIVERSAL FLASK WASHING WITH DRYING SYSTEM - 20 POSITIONS

- suitable for washing and drying narrow-necked glassware up to 490 mm in height
- equipped with the following nozzles: 2 x U6260 (260 mm), 2 x U6240 (240 mm), 2 x U6220 (220 mm), 3 x U4180 (180 mm), 2 x U4160 (160 mm), 2 x U4140 (140 mm), 3 x U3110 (110 mm), 4 x U390 (90 mm), 1 x UC6 (curved)
- half trolley for free loading, to be completed with test tube baskets, Erlenmeyer flask supports, basket CSK2
- positioned on the lower level
- made of stainless steel



Machines

GW4090	GW4090A	GW4090BXC	GW4090BXCA	GW4090BXP
GW4090C	GW4090CA	GW4090P	GW4090PA	GW4260-00-000
GW4260-S0-000	GW4260-SC-000	GW4290-00-000	GW4290-SC-000	

LM22S (art. 901746)

UPPER UNIVERSAL FLASK WASHING – 22 POSITIONS

- suitable for washing narrow-necked glassware up to 225 mm in height
- equipped with the following nozzles: 12 x U4140 (140 mm), 5 x U3110 (110 mm), 5 x U390 (90 mm)
- positioned on the upper trolley level D-CS1
- made of stainless steel



Machines

GW1245-S0-100

LM24 (art. 901345)

UNIVERSAL FLASK WASHING - 24 POSITIONS

- suitable for washing narrow-necked glassware up to 490 mm in height
- equipped with the following nozzles: 6 x U6240 (240 mm), 5 x U6220 (220 mm), 6 x U4160 (160 mm), 5 x U4140 (140 mm), 2 x U3110 (110 mm)
- positioned on the lower trolley level D-CS2
- made of stainless steel



Machines

GW1245-S0-100

LM40 (art. 900023)

UNIVERSAL FLASK WASHING - 40 POSITIONS

- suitable for washing narrow-necked glassware up to 490 mm in height
- equipped with the following nozzles: 5 x U6260 (260 mm), 5 x U6240 (240 mm), 5 x U6220 (220 mm), 5 x U4180 (180 mm), 5 x U4160 (160 mm), 5 x U4140 (140 mm), 5 x U3110 (110 mm), 5 x U390 (90 mm), 1 x UC6 (curved)
- positioned on the lower level
- made of stainless steel

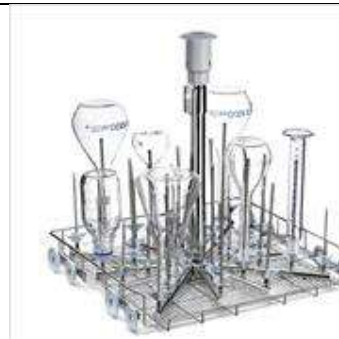

Machines

GW0260-00-00J	GW0260-S0-00J	GW1260-00-000	GW1260-S0-000	GW1260-SC-000
GW3060BX	GW3060BXA	GW3060BXC	GW3060P	GW3060PA
GW3060S	GW3060SA	GW3060SC	GW3060SCA	

LM40BX (art. 902626)

FLEXIBLE FLASK WASHING - 40 POSITIONS

- suitable for washing narrow-necked glassware up to 490mm in height
- 40 positions rack without nozzles
- to be equipped with 40 nozzles (unused positions must be covered with caps cod. TAPPOUG)
- positioned on the lower level
- made of stainless steel
- for nozzles configuration consult your Area Manager



Machines

GW0260-00-00J	GW0260-S0-00J	GW1260-00-000	GW1260-S0-000	GW1260-SC-000
GW3060BX	GW3060BXA	GW3060BXC	GW3060P	GW3060PA
GW3060S	GW3060SA	GW3060SC	GW3060SCA	

LM40BXDS (art. 903962)

FLEXIBLE FLASK WASHING WITH DRYING SYSTEM - 40

POSITIONS

- suitable for washing and drying narrow-necked glassware up to 490mm in height
- 40 positions rack without nozzles
- to be equipped with 40 nozzles (unused positions must be covered with caps cod. TAPPOUG)
- positioned on the lower level
- made of stainless steel
- for nozzles configuration consult your Area Manager



Machines

GW4090	GW4090A	GW4090BXC	GW4090BXCA	GW4090BXP
GW4090C	GW4090CA	GW4090P	GW4090PA	GW4260-00-000
GW4260-S0-000	GW4260-SC-000	GW4290-00-000	GW4290-SC-000	

LM40DS (art. 900027)

UNIVERSAL FLASK WASHING WITH DRYING SYSTEM - 40

POSITIONS

- suitable for washing and drying of narrow neck glassware up to 490 mm in height
- equipped with the following nozzles: 5 x U6260 (260 mm), 5 x U6240 (240 mm), 5 x U6220 (220 mm), 5 x U4180 (180 mm), 5 x U4160 (160 mm), 5 x U4140 (140 mm), 5 x U3110 (110 mm), 5 x U390 (90 mm), 1 x UC6 (curved)
- positioned on the lower level
- made of stainless steel

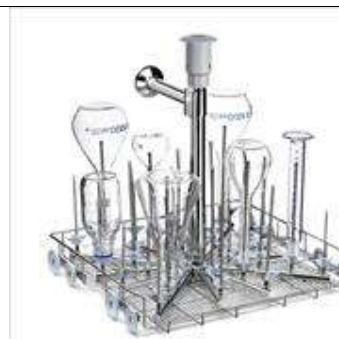

Machines

GW4090	GW4090A	GW4090BXC	GW4090BXCA	GW4090BXP
GW4090C	GW4090CA	GW4090P	GW4090PA	GW4260-00-000
GW4260-S0-000	GW4260-SC-000	GW4290-00-000	GW4290-SC-000	

LM40ICS1 (art. 905047)

2-LEVEL TROLLEY WITH MIXED WASHING SYSTEM, INJECTION ON THE LOWER LEVEL AND SPRAYING ON THE UPPER LEVEL

- 2-level trolley with mixed washing system, injection on the lower level and spraying on the upper level
- Upper level complete with sprayer suitable for positioning supports for wide neck glassware and baskets
- Basic injection level suitable for washing narrow-necked glassware up to hmax 205 mm
- Complete with n. 34 nozzles U4140, n. 1 curved UC6 nozzle and n. 6 caps TAPPOUG
- Made of stainless steel

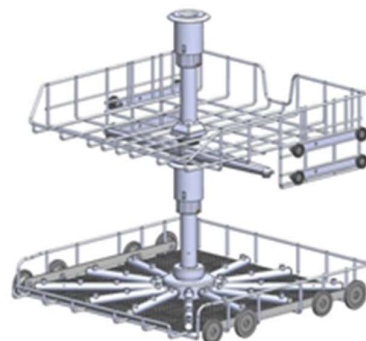

Machines

GW0260-00-00J	GW0260-S0-00J	GW1260-00-000	GW1260-S0-000	GW1260-SC-000
GW3060BX	GW3060BXA	GW3060BXC	GW3060P	GW3060PA
GW3060S	GW3060SA	GW3060SC	GW3060SCA	

LM40ICS1DS (art. 905048)

2-LEVEL TROLLEY WITH MIXED WASHING SYSTEM, INJECTION ON THE LOWER LEVEL AND SPRAYING ON THE UPPER LEVEL

- 2-level trolley with mixed washing system, injection on the lower level and spraying on the upper level
- Upper level complete with sprayer suitable for positioning supports for wide neck glassware and baskets, with dryer joint
- Basic injection level suitable for washing narrow-necked glassware up to hmax 205 mm
- Complete with n. 34 nozzles U4140, n. 1 curved UC6 nozzle and n. 6 caps TAPPOUG
- Made of stainless steel

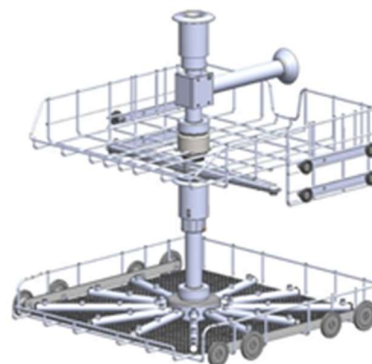

Machines

GW4090	GW4090A	GW4090BXC	GW4090BXCA	GW4090BXP
GW4090C	GW4090CA	GW4090P	GW4090PA	GW4260-00-000
GW4260-S0-000	GW4260-SC-000	GW4290-00-000	GW4290-SC-000	

LM40S (art. 900026)

UPPER FLASK WASHING - 40 POSITIONS

- suitable for washing narrow-necked glassware up to 225 mm height
- equipped with the following nozzles: 40 x U4140 (140 mm)
- positioned on the upper level to be coupled with CS2
- made of stainless steel



Machines

GW0260-00-00J	GW0260-S0-00J	GW1260-00-000	GW1260-S0-000	GW1260-SC-000
GW3060BX	GW3060BXA	GW3060BXC	GW3060P	GW3060PA
GW3060S	GW3060SA	GW3060SC	GW3060SCA	

LM40SBX (art. 903668)

FLEXIBLE FLASK WASHING - 40 POSITIONS

- suitable for washing and drying narrow-necked glassware up to 200 mm in height
- 40 positions rack without nozzles
- to be equipped with 40 nozzles (unused positions must be covered with caps cod. TAPPOUG)
- positioned on the upper level
- made of stainless steel
- for nozzles configuration consult your Area Manager



Machines

GW0260-00-00J	GW0260-S0-00J	GW1260-00-000	GW1260-S0-000	GW1260-SC-000
GW3060BX	GW3060BXA	GW3060BXC	GW3060P	GW3060PA
GW3060S	GW3060SA	GW3060SC	GW3060SCA	

LM40SBXDS (art. 903986)

FLEXIBLE FLASK WASHING WITH DRYING SYSTEM - 40

POSITIONS

- suitable for washing and drying narrow-necked glassware up to 490mm in height
- 40 positions rack without nozzles
- to be equipped with 40 nozzles (unused positions must be covered with caps cod. TAPPOUG)
- positioned on the upper level
- made of stainless steel
- for nozzles configuration consult your Area Manager



Machines

GW4090	GW4090A	GW4090BXC	GW4090BXCA	GW4090BXP
GW4090C	GW4090CA	GW4090P	GW4090PA	GW4260-00-000
GW4260-S0-000	GW4260-SC-000	GW4290-00-000	GW4290-SC-000	

LM40SDS (art. 900300)

UPPER FLASK WASHING WITH DRYING SYSTEM - 40

POSITIONS

- suitable for washing and drying of narrow neck glassware up to 225 mm height
- equipped with the following nozzles: 40 x U4140 (140 mm)
- positioned on the upper level to be coupled with CS2
- made of stainless steel



Machines

GW4090	GW4090A	GW4090BXC	GW4090BXCA	GW4090BXP
GW4090C	GW4090CA	GW4090P	GW4090PA	GW4260-00-000
GW4260-S0-000	GW4260-SC-000	GW4290-00-000	GW4290-SC-000	

LM46 (art. 903784)

UNIVERSAL FLASK WASHING - 46 POSITIONS

- suitable for washing narrow-necked glassware up to 220 mm in height
- upper basket insert equipped with the following nozzles: 12 x U4140 (140 mm), 6 x U390 (90 mm), 6 x U3110 (110 mm)
- lower basket insert equipped with the following nozzles: 6 x U4140 (140 mm), 2 x U390 (90 mm), 2 x U3110 (110 mm), 2 x U6220 (220 mm), 2 x U6240 (240 mm), 2 x U6260 (260 mm), 2 x U4180 (160 mm), 6 x U4160 (160 mm), 1 x UC6 (curved)
- positioned on the rack levels of D-CS1 e D-CS2
- made of stainless steel



Machines

GW1245-S0-100

LM80 (art. 900028)

UNIVERSAL FLASK WASHING, TWO WASHING LEVELS

- suitable for washing narrow-necked glassware up to 225 mm in height
- capacity: 68 pieces
- equipped with the following nozzles: 68 x U4140 (140 mm), 1 x UC6 (curved)
- equipped with 12 caps (cod. TAPPOUG)
- positioned on 2 independent levels
- made of stainless steel



Machines

GW0260-00-00J	GW0260-S0-00J	GW1260-00-000	GW1260-S0-000	GW1260-SC-000
GW3060BX	GW3060BXA	GW3060BXC	GW3060P	GW3060PA
GW3060S	GW3060SA	GW3060SC	GW3060SCA	

LM80DS (art. 900029)

UNIVERSAL FLASK WASHING WITH DRYING SYSTEM - TWO WASHING LEVELS

- suitable for washing and drying of narrow neck glassware up to 225mm in height
- capacity: 68 pieces
- equipped with the following nozzles: 68 x U4140 (140 mm), 1 x UC6 (curved)
- equipped with 12 caps (cod. TAPPOUG)
- positioned on 2 independent levels
- made of stainless steel



Machines

GW4090	GW4090A	GW4090BXC	GW4090BXCA	GW4090BXP
GW4090C	GW4090CA	GW4090P	GW4090PA	GW4260-00-000
GW4260-S0-000	GW4260-SC-000	GW4290-00-000	GW4290-SC-000	

LM80I (art. 904268)

LOWER FLASK WASHING - 34 POSITIONS

- suitable for washing and drying of narrow neck glassware up to 225 mm height
- equipped with the following nozzles: 34 x U4140 (140 mm), 1 x UC6 (curved)
- equipped with 6 caps (cod. TAPPOUG)
- positioned on the lower level
- to be combined with the upper trolley with water supply system to the lower level trolley
- made of stainless steel



Machines

GW0260-00-00J	GW0260-S0-00J	GW1260-00-000	GW1260-S0-000	GW1260-SC-000
GW3060BX	GW3060BXA	GW3060BXC	GW3060P	GW3060PA
GW3060S	GW3060SA	GW3060SC	GW3060SCA	

LM80SBX (art. 903981)

FLEXIBLE FLASK WASHING - 40 POSITIONS

- suitable for washing and drying narrow-necked glassware up to 225 mm in height
- 40 positions rack without nozzles
- to be equipped with 40 nozzles (unused positions must be covered with caps cod. TAPPOUG)
- n. 6 caps are provided
- positioned on the upper level
- made of stainless steel
- for nozzles configuration consult your Area Manager



Machines

GW4090	GW4090A	GW4090BXC	GW4090BXCA	GW4090BXP
GW4090C	GW4090CA	GW4090P	GW4090PA	GW4260-00-000
GW4260-S0-000	GW4260-SC-000	GW4290-00-000	GW4290-SC-000	

LM80SBXDS (art. 903982)

FLEXIBLE FLASK WASHING WITH DRYING SYSTEM - 40 POSITIONS

- suitable for washing and drying narrow-necked glassware up to 225 mm in height
- 40 positions rack without nozzles
- to be equipped with 40 nozzles (unused positions must be covered with caps cod. TAPPOUG)
- n.6 caps are provided
- positioned on the upper level
- made of stainless steel
- for nozzles configuration consult your Area Manager



Machines

GW4090	GW4090A	GW4090BXC	GW4090BXCA	GW4090BXP
GW4090C	GW4090CA	GW4090P	GW4090PA	GW4260-00-000
GW4260-S0-000	GW4260-SC-000	GW4290-00-000	GW4290-SC-000	

LM80SDS (art. 903211)

UPPER FLASK WASHING WITH DRYING SYSTEM - 34 POSITIONS

- suitable for washing and drying of narrow neck glassware up to 225 mm height
- equipped with the following nozzles: 40 x U4140 (140 mm)
- equipped with 6 caps (cod. TAPPOUG)
- positioned on the upper level
- to be coupled with an injection rack on the lower level
- made of stainless steel



Machines

GW4090	GW4090A	GW4090BXC	GW4090BXCA	GW4090BXP
GW4090C	GW4090CA	GW4090P	GW4090PA	GW4260-00-000
GW4260-S0-000	GW4260-SC-000	GW4290-00-000	GW4290-SC-000	

LM112 (art. ...)

UNIVERSAL FLASK WASHING - TWO WASHING LEVELS

- suitable for washing and drying of narrow neck glassware up to 225mm in height
- capacity: 136 pieces
- positioned on 2 independent levels
- higher level composed of 68 positions equipped with the following nozzles: 24 x U4140, 8 x U390, 12 x U4160, 12 x U3110 + 20 caps (cod. TAPPOUG)
- lower level composed of 68 positions equipped with the following nozzles: 24 x U4140, 8 x U390, 12 x U4160, 12 x U3110, 1 x UC6 (curved) + 20 caps (cod. TAPPOUG)
- made of stainless steel



Machines

GW0260-00-00J	GW0260-S0-00J	GW1260-00-000	GW1260-S0-000	GW1260-SC-000
GW3060BX	GW3060BXA	GW3060BXC	GW3060P	GW3060PA
GW3060S	GW3060SA	GW3060SC	GW3060SCA	

LM112DS (art. 905659)

UNIVERSAL FLASK WASHING WITH DRYING SYSTEM - TWO

WASHING LEVELS

- suitable for washing and drying of narrow neck glassware up to 225mm in height
- capacity: 136 pieces
- positioned on 2 independent levels
- higher level composed of 68 positions equipped with the following nozzles: 24 x U4140, 8 x U390, 12 x U4160, 12 x U3110 + 20 caps (cod. TAPPOUG)
- lower level composed of 68 positions equipped with the following nozzles: 24 x U4140, 8 x U390, 12 x U4160, 12 x U3110, 1 x UC6 (curved) + 20 caps (cod. TAPPOUG)
- made of stainless steel



Machines

GW4090	GW4090A	GW4090BXC	GW4090BXCA	GW4090BXP
GW4090C	GW4090CA	GW4090P	GW4090PA	GW4260-00-000
GW4260-S0-000	GW4260-SC-000	GW4290-00-000	GW4290-SC-000	

LPM24 (art. 901379)

PIPETTES/FLASK WASHING TROLLEY - 12+12 POSITIONS

- suitable for washing narrow-necked glassware e pipettes up to 490 mm in height
- equipped with the following nozzles: 4 x U6240 (240 mm), 2 x U6220 (220 mm), 2 x U4160 (160 mm), 2 x U4140 (140 mm), 2 x U3110 (110 mm), 12 x ULB40
- positioned on the lower trolley level D-CS2
- made of stainless steel



Machines

GW2145	GW2145A
--------	---------

LR4 (art. 900237)

REACTOR WASHING TROLLEY

- suitable for washing 4 reactors with 3 / 5 necks of 3 liters max or up to 12 pieces of narrow neck glassware
- equipped with the following nozzles: 12 x U6260 (260 mm)
- positioned on the lower level
- made of stainless steel

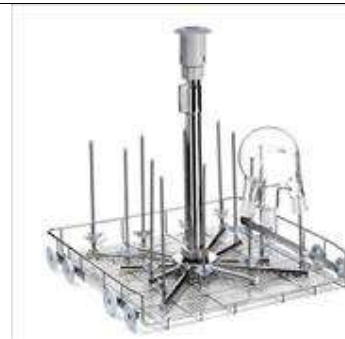

Machines

GW0260-00-00J	GW0260-S0-00J	GW1260-00-000	GW1260-S0-000	GW1260-SC-000
GW3060BX	GW3060BXA	GW3060BXC	GW3060P	GW3060PA
GW3060S	GW3060SA	GW3060SC	GW3060SCA	

LR4DS (art. 900238)

REACTOR WASHING TROLLEY WITH DRYING SYSTEM

- suitable for washing and drying of 4 reactors with 3 / 5 necks of 3 liters max or up to 12 pieces of narrow neck glassware
- equipped with the following nozzles: 12 x U6260 (260 mm)
- positioned on the lower level
- made of stainless steel

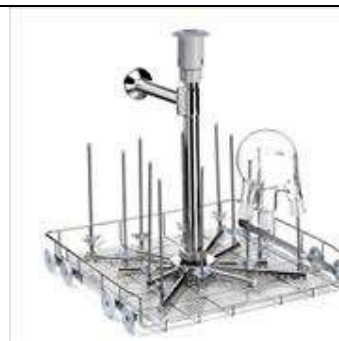

Machines

GW4090	GW4090A	GW4090BXC	GW4090BXCA	GW4090BXP
GW4090C	GW4090CA	GW4090P	GW4090PA	GW4260-00-000
GW4260-S0-000	GW4260-SC-000	GW4290-00-000	GW4290-SC-000	

LT20 (art. 900239)

TROLLEY FOR FISCHER TUBES

- suitable for washing of 12 fischer tubes max height 550 mm and 6 pieces of narrow neck glassware
- equipped with the following nozzles: 12 x U6370 (370 mm), 2 x U6220 (220 mm), 2 x U4160 (160 mm), 2 x U390 (90 mm)
- positioned on the lower level
- made of stainless steel



Machines

GW0260-00-00J	GW0260-S0-00J	GW1260-00-000	GW1260-S0-000	GW1260-SC-000
GW3060BX	GW3060BXA	GW3060BXC	GW3060P	GW3060PA
GW3060S	GW3060SA	GW3060SC	GW3060SCA	

LT20DS (art. 900759)

TROLLEY FOR FISCHER TUBES WITH DRYING SYSTEM

- suitable for washing and drying of 12 fischer tubes max height 550 mm and 6 pieces of narrow-neck glassware
- equipped with the following nozzles: 12 x U6370 (370 mm), 2 x U6220 (220 mm), 2 x U4160 (160 mm), 2 x U390 (90 mm)
- positioned on the lower level
- made of stainless steel



Machines

GW4090	GW4090A	GW4090BXC	GW4090BXCA	GW4090BXP
GW4090C	GW4090CA	GW4090P	GW4090PA	GW4260-00-000
GW4260-S0-000	GW4260-SC-000	GW4290-00-000	GW4290-SC-000	

Pipette injection trolleys *for undercounter machines*

LPT100 (art. 900220)

PIPETTE WASHER TROLLEY

- suitable for washing 100 standard pipettes max height 450 mm max diameter 8.5 mm
- positioned on the lower level
- made of stainless steel



Machines

GW0260-00-00J	GW0260-S0-00J	GW1260-00-000	GW1260-S0-000	GW1260-SC-000
GW3060BX	GW3060BXA	GW3060BXC	GW3060P	GW3060PA
GW3060S	GW3060SA	GW3060SC	GW3060SCA	

LPT100DS (art. 900219)

PIPETTE WASHER TROLLEY WITH DRYING SYSTEM

- suitable for washing and drying 100 standard pipettes max height 450 mm max diameter 8.5 mm
- positioned on the lower level
- made of stainless steel



Machines

GW4090	GW4090A	GW4090BXC	GW4090BXCA	GW4090BXP
GW4090C	GW4090CA	GW4090P	GW4090PA	GW4260-00-000
GW4260-S0-000	GW4260-SC-000	GW4290-00-000	GW4290-SC-000	

LPV40 (art. 900242)

PIPETTE WASHER TROLLEY

- suitable for washing 20 volumetric pipettes max height 550 mm + 20 standard pipettes max height 490 mm
- positioned on the lower level
- made of stainless steel



Machines

GW0260-00-00J	GW0260-S0-00J	GW1260-00-000	GW1260-S0-000	GW1260-SC-000
GW3060BX	GW3060BXA	GW3060BXC	GW3060P	GW3060PA
GW3060S	GW3060SA	GW3060SC	GW3060SCA	

LPV40DS (art. 900243)

PIPETTE WASHER TROLLEY WITH DRYING SYSTEM

- suitable for washing and drying 20 volumetric pipettes max height 550 mm + 20 standard pipettes max height 490 mm
- positioned on the lower level
- made of stainless steel

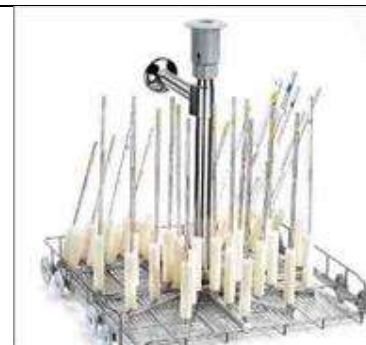

Machines

GW4090	GW4090A	GW4090BXC	GW4090BXCA	GW4090BXP
GW4090C	GW4090CA	GW4090P	GW4090PA	GW4260-00-000
GW4260-S0-000	GW4260-SC-000	GW4290-00-000	GW4290-SC-000	

Mixed injection trolleys (pipette + narrow neck) for undercounter machines

LPM20/20 (art. 900240)

MIXED WASHING TROLLEY FLASKS / PIPETTES – 20 + 20

POSITIONS

- suitable for washing 20 pipettes up to 550 mm + 20 pieces of narrow-neck glassware
- equipped with the following nozzles: 2 x U6260 (260 mm), 2 x U6240 (240 mm), 2 x U6220 (220 mm), 3 x U4180 (180 mm), 2 x U4160 (160 mm), 2 x U4140 (140 mm), 3 x U3110 (110 mm), 4 x U390 (90 mm), 1 x UC6 (curved), 20 x ULB40 for pipettes max height 550 mm
- positioning on lower level
- made of stainless steel



Machines

GW0260-00-00J	GW0260-S0-00J	GW1260-00-000	GW1260-S0-000	GW1260-SC-000
GW3060BX	GW3060BXA	GW3060BXC	GW3060P	GW3060PA
GW3060S	GW3060SA	GW3060SC	GW3060SCA	

LPM2010 (art. 902891)

WASHING TROLLEY FOR FLASKS / PIPETTES / TEST TUBES - 20

POSITIONS

- suitable for washing 10 pipettes up to 550 mm + 20 pieces of narrow-neck glassware + 1/4 free rack, to be completed with a test tube holding baskets of the CP series
- equipped with the following nozzles: 2 x U6260 (260 mm), 2 x U6240 (240 mm), 2 x U6220 (220 mm), 3 x U4180 (180 mm), 2 x U4160 (160 mm), 2 x U4140 (140 mm), 3 x U3110 (110 mm), 4 x U390 (90 mm), 1 x UC6 (curved), 10 x ULB40 for pipettes max height 550 mm
- positioned on the lower level
- made of stainless steel

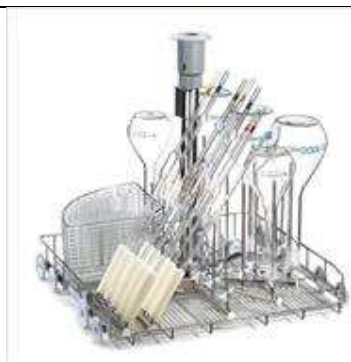

Machines

GW0160	GW0160A	GW0160S	GW0160SA	GW0260-00-00J
GW0260-S0-00J	GW1160	GW1160A	GW1160C	GW1160CA
GW1160S	GW1160SA	GW1160SC	GW1160SCA	GW1260-00-000
GW1260-S0-000	GW1260-SC-000	GW3060BX	GW3060BXA	GW3060BXC
GW3060BXCA	GW3060P	GW3060PA	GW3060S	GW3060SA
GW3060SC	GW3060SCA			

LPM2010DS (art. 902051)

WASHING TROLLEY FOR FLASKS / PIPETTES / TEST TUBES - 20 POSITIONS WITH DRYING SYSTEM

- suitable for washing and drying 10 pipettes up to 550 mm + 20 pieces of narrow-neck glassware + 1/4 free rack, to be completed with a test tube holding baskets of the CP series
- equipped with the following nozzles: 2 x U6260 (260 mm), 2 x U6240 (240 mm), 2 x U6220 (220 mm), 3 x U4180 (180 mm), 2 x U4160 (160 mm), 2 x U4140 (140 mm), 3 x U3110 (110 mm), 4 x U390 (90 mm), 1 x UC6 (curved), 10 x ULB40 for pipettes max height 550 mm
- positioned on the lower level
- made of stainless steel



Machines

GW4090	GW4090A	GW4090BXC	GW4090BXCA	GW4090BXP
GW4090C	GW4090CA	GW4090P	GW4090PA	GW4260-00-000
GW4260-S0-000	GW4260-SC-000	GW4290-00-000	GW4290-SC-000	

LPM2020DS (art. 900241)

MIXED WASHING TROLLEY FLASKS / PIPETTES – 20+20 POSITIONS WITH DRYING SYSTEM

- suitable for washing and drying 20 pipettes up to 550 mm + 20 pieces of narrow-neck glassware equipped with the following nozzles :
- equipped with the following nozzles: 2 x U6260 (260 mm), 2 x U6240 (240 mm), 2 x U6220 (220 mm), 3 x U4180 (180 mm), 2 x U4160 (160 mm), 2 x U4140 (140 mm), 3 x U3110 (110 mm), 4 x U390 (90 mm), 1 x UC6 (curvo), 20 x ULB40 for pipettes max height 550 mm
- positioned on the lower level
- made of stainless steel



Machines

GW4090	GW4090A	GW4090BXC	GW4090BXCA	GW4090BXP
GW4090C	GW4090CA	GW4090P	GW4090PA	GW4260-00-000
GW4260-S0-000	GW4260-SC-000	GW4290-00-000	GW4290-SC-000	

Injection trolleys for large glassware *for undercounter machines*

LB1-20DS (art. 902605)

TROLLEY FOR ONE LARGE BOTTLE OR DRUM

- injection trolley for washing and drying one large bottle and/or drum
- bottle maximum dimensions DIAMETERxH: 300 x 350 mm
- made of stainless steel



Machines

GW4090	GW4090A	GW4090BXC	GW4090BXCA	GW4090BXP
GW4090C	GW4090CA	GW4090P	GW4090PA	GW4260-00-000
GW4260-S0-000	GW4260-SC-000	GW4290-00-000	GW4290-SC-000	

LC8M8 (art. 905227)

INJECTION TROLLEY FOR CYLINDERS AND MIXED GLASS

- suitable for the simultaneous washing of 8 medium - large cylinders and 8 mixed glassware such as flasks, bottles
- maximum treatable volumes of the cylinders at the same time: 2 cylinders of 2 liters + 2 cylinders of 1 liter + 4 of 0.5 liters
- equipped with the following nozzles: 8 x U6300 (300 mm), 8 x U490 (90 mm)
- positioning on a lower level
- made of stainless steel

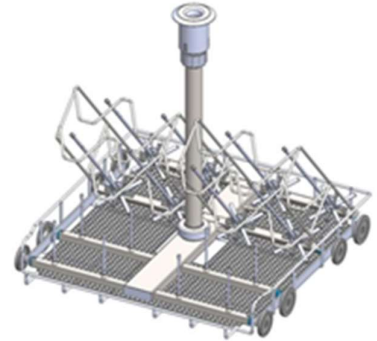

Machines

GW0260-00-00J	GW0260-S0-00J	GW1260-00-000	GW1260-S0-000	GW1260-SC-000
GW3060BX	GW3060BXA	GW3060BXC	GW3060P	GW3060PA
GW3060S	GW3060SA	GW3060SC	GW3060SCA	

LC8M8DS (art. 905228)

INJECTION TROLLEY FOR CYLINDERS AND MIXED GLASS WITH DRYING SYSTEM

- suitable for the simultaneous washing of 8 medium - large cylinders and 8 mixed glassware such as flasks, bottles
- maximum treatable volumes of the cylinders at the same time: 2 cylinders of 2 liters + 2 cylinders of 1 liter + 4 of 0.5 liters
- equipped with the following nozzles: 8 x U6300 (300 mm), 8 x U490 (90 mm)
- positioning on a lower level
- made of stainless steel

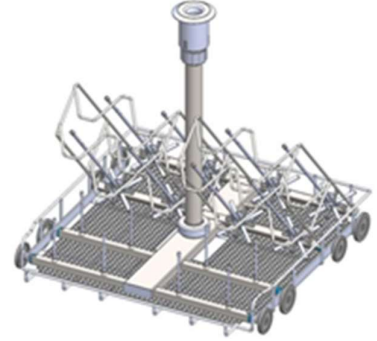

Machines

GW4090	GW4090A	GW4090BXC	GW4090BXCA	GW4090BXP
GW4090C	GW4090CA	GW4090P	GW4090PA	GW4260-00-000
GW4260-S0-000	GW4260-SC-000	GW4290-00-000	GW4290-SC-000	

Injection trolleys for vials and conical centrifuge test tubes *for undercounter machines*

KP100 (art. 900244)

UPPER INJECTION TROLLEY FOR TEST TUBES

- suitable for internal washing of vials, conical centrifuge tubes, centrifuge rotors
- equipped with the following nozzles: 104 x U390 (90 mm)
- positioned on the upper level
- made of stainless steel



Machines

GW0260-00-00J	GW0260-S0-00J	GW1260-00-000	GW1260-S0-000	GW1260-SC-000
GW3060BX	GW3060BXA	GW3060BXC	GW3060P	GW3060PA
GW3060S	GW3060SA	GW3060SC	GW3060SCA	

KP100DS (art. 900245)

UPPER INJECTION TROLLEY FOR TEST TUBES WITH DRYING SYSTEM

- suitable for internal washing and drying of vials, conical centrifuge tubes, centrifuge rotors
- equipped with the following nozzles: 104 x U390 (90 mm)
- positioned on the upper level
- made of stainless steel



Machines

GW4090	GW4090A	GW4090BXC	GW4090BXCA	GW4090BXP
GW4090C	GW4090CA	GW4090P	GW4090PA	GW4260-00-000
GW4260-S0-000	GW4260-SC-000	GW4290-00-000	GW4290-SC-000	

KP200 (art. 900246)

TWO LEVEL INJECTION TROLLEY FOR TEST TUBES

- suitable for internal washing of vials, conical centrifuge tubes, centrifuge rotors
- equipped with the following nozzles: 208 x U390 (90 mm)
- positioned on two levels
- made of stainless steel



Machines

GW0260-00-00J	GW0260-S0-00J	GW1260-00-000	GW1260-S0-000	GW1260-SC-000
GW3060BX	GW3060BXA	GW3060BXC	GW3060P	GW3060PA
GW3060S	GW3060SA	GW3060SC	GW3060SCA	

KP200DS (art. 900247)

TWO LEVEL INJECTION TROLLEY FOR TEST TUBES WITH DRYING SYSTEM

- suitable for internal washing and drying of vials, conical centrifuge tubes, centrifuge rotors
- equipped with the following nozzles: 208 x U390 (90 mm)
- positioned on two levels
- made of stainless steel



Machines

GW4090	GW4090A	GW4090BXC	GW4090BXCA	GW4090BXP
GW4090C	GW4090CA	GW4090P	GW4090PA	GW4260-00-000
GW4260-S0-000	GW4260-SC-000	GW4290-00-000	GW4290-SC-000	

KP200-U355 (art. 905657)

TWO-LEVEL INJECTION TROLLEY FOR VIALS

- suitable for internal washing of even small vials, conical centrifuge tubes, centrifuge rotors
- equipped with the following nozzles: 208 x U355 (55 mm)
- placement on two levels
- made of stainless steel



Machines

GW0260-00-00J	GW0260-S0-00J	GW1260-00-000	GW1260-S0-000	GW1260-SC-000
GW3060BX	GW3060BXA	GW3060BXC	GW3060P	GW3060PA
GW3060S	GW3060SA	GW3060SC	GW3060SCA	

KP200DS-U355 (art. 905658)

TWO-LEVEL INJECTION TROLLEY FOR VIALS WITH DRYING SYSTEM

- suitable for internal washing of even small vials, conical centrifuge tubes, centrifuge rotors
- equipped with the following nozzles: 208 x U355 (55 mm)
- placement on two levels
- made of stainless steel



Machines

GW4090	GW4090A	GW4090BXC	GW4090BXCA	GW4090BXP
GW4090C	GW4090CA	GW4090P	GW4090PA	GW4260-00-000
GW4260-S0-000	GW4260-SC-000	GW4290-00-000	GW4290-SC-000	

KP60 (art. 901872)

UPPER INJECTION TROLLEY FOR TEST TUBES

- suitable for internal washing of vials, conical centrifuge tubes, centrifuge rotors
- equipped with the following nozzles: 60 x U390 (90 mm)
- positioned on the upper level
- made of stainless steel



Machines

GW1245-S0-100

Base trolleys and insert *for large dimension machines*

C61 (art. 900934)

TROLLEY FOR LEVEL I (LOWER)

- to be used as a base for spray washing and as support for multi-nozzle systems
- equipped with bottom sprayer
- complete with bottom rack in stainless steel mesh
- made of stainless steel



Machines

GW6290DS GW6290DSG

C62B (art. 905548)

BASE INSERT WITH SPRAYER FOR LEVELS II AND III (MIDDLE AND UPPER)

- Insert equipped with sprayarm
- for washing levels 2 and 3 (middle and upper)
- with higher side edges to better locate safely supports and glassware
- made of stainless steel



Machines

GW6290DS GW6290DSG

C63 (art. 900936)

UNIVERSAL SUPPORT FOR INJECTION SYSTEMS

- trolley for levels II and III (middle and upper)
- to be used as a telescopic support frame for holding injection systems
- made of stainless steel



Machines

GW6290DS GW6290DSG

CL7015 (art. 905704)

BASIC WASHING INSERT

- Shelf to be used as a base for spray washing on basic level GW7015 family machines
- served as a sprayer on the bottom of the tank
- made of stainless steel complete with two caps for lateral delivery connections

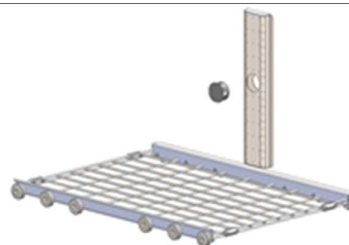

Machines

GW7015 GW7015M GW7015T

CL6010 (art. 905163)

BASE INSERT FOR SPRAY WASHING

- Insert suitable for GW6010L-GW6010LX-GW6010T and GW7010-GW7010T
- Shelf to be used as a base for spraying washing
- basic level, served by the sprayer at the bottom of the tank
- made of stainless steel
- complete with two caps for side water supply connections



Machines

GW6010L GW6010LX GW6010T GW7010 GW7010T

CLB310UNIV (art. 904830)

BASE RACK FOR GLASSWARE

- Basic rack for glassware
- Possibility of fitting up to 3 different levels
- n°3 couples of removable rails are included
- Bolted rails (no welded)
- Adjustable position of the rails (on five available levels)
- The inserts are not included
- Made of stainless steel



Machines

GW6010L GW6010LX GW6010T GW6010TM GW7010
 GW7010M GW7010T GW7010TM

CLB315UNIV (art. 905071)

BASIC GLASSWARE WASHER TROLLEY

- basic trolley for washing glassware
- complete with 3 pairs of removable rails, to be fixed to the frame with threaded holes at 5 different heights
- possibility of using a maximum of 3 washing shelves at the same time
- complete with 3 blades to block unused water outlets and 2 plugs to close unused levels.
- inserts not included
- made of stainless steel



Machines

GW7015 GW7015T

INSL6010R (art. 905042)

WASHING INSERT

- Insert suitable for the models of the family GW6010ML and GW6010MLX
- Shelf to be used as a base for spraying washing
- Basic level, served by a sprinkler on the bottom of the tank
- Made of stainless steel

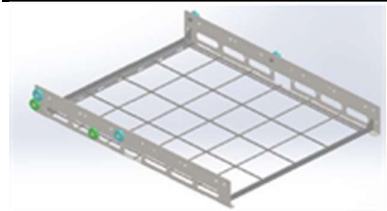

Machines

GW6010ML GW6010MLX

INSPLAV10 (art. 903545)

SINGLE WASHING LEVEL

- intermediate level with integrated spraying arm
- made of stainless steel



Machines

GW6010L GW6010T GW6010TM GW7010 GW7010M
 GW7010T GW7010TM

INSPLAV10R (art. 904903)

SINGLE WASHING LEVEL

- intermediate level with integrated spraying arm
- level with rails compatible with "ML" glassware washers
- made of stainless steel



Machines

GW6010ML GW6010MLX

INSPLAV15 (art. 904568)

WASHING LEVEL INSERT WITH DOUBLE SPRAY ARM

- intermediate level with integrated double spraying arm
- made of stainless steel

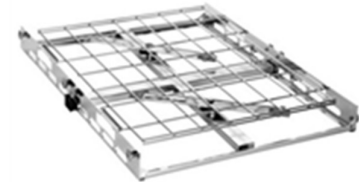

Machines

GW7015 GW7015T

LCB6010 (art. 903883)

BASE RACK FOR GLASSWARE

- base rack for glassware
- equipped with a single level to accommodate up to 2 collectors (one for each single half-level)
- made of stainless steel



Machines

GW6010T GW6010TM GW7010 GW7010M GW7010T
GW7010TM

LCB6010R (art. 905004)

BASE RACK FOR GLASSWARE

- base rack for glassware
- equipped with a single level to accommodate up to 2 collectors (one for each single half-level)
- made of stainless steel



Machines

GW6010ML

GW6010MLX

LCB7015 (art. 904312)

BASE RACK FOR GLASSWARE

- base rack for glassware
- equipped with a single level to accommodate up to 2 collectors (one for each single half-level)
- made of stainless steel



Machines

GW7015

GW7015T

Narrow neck glassware injection trolleys *for large dimension machines*

COBE63 (art. 954383)

COLLECTOR FOR FLASKS

- suitable for washing 3 flasks up to 3 liters (max diameter: 188 mm) or 6 glassware up to 2 liters (max diameter: 140 mm)
- equipped with the following nozzles: 6 x U4180 (180 mm)
- n. 2 long dividers
- n. 2 short dividers
- use on trolleys LCB6010
- overall dimension equal to half of the washing surface



Machines

GW6010L	GW6010LX	GW6010T	GW6010TM	GW7010
GW7010M	GW7010T	GW7010TM		

COBE6315 (art. 955036)

COLLECTOR FOR FLASKS

- suitable for washing 6 flasks up to 3 liters (max diameter: 188 mm) or 8 glassware up to 2 liters (max diameter: 140 mm)
- equipped with the following nozzles: 13 x U4180 (180 mm)
- n. 2 long dividers
- n. 2 short dividers
- use on trolleys LCB7015
- overall dimension equal to half of the washing surface



Machines

GW7015	GW7015T
--------	---------

COBE63R (art. 955785)

COLLECTOR FOR FLASKS

- suitable for washing 3 flasks up to 3 liters (max diameter: 188 mm) or 6 glassware up to 2 liters (max diameter: 140 mm)
- equipped with the following nozzles: 6 x U4180 (180 mm)
- n. 2 long dividers
- n. 2 short dividers
- use on trolleys LCB6010R
- overall dimension equal to half of the washing surface

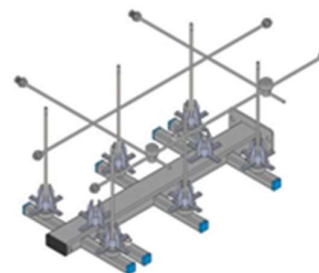

Machines

GW6010ML	GW6010MLX
----------	-----------

INS12U4180DV (art. 903954)

UNIVERSAL INJECTION TROLLEY WITH 12 POSITIONS

- suitable for washing 12 bottles up to 1 liter or 6 flasks up to 2 liters
- equipped with the following nozzles: 12 x U4180 (180 mm), 6 x U6260 (260 mm)
- equipped with 12 caps for configuration
- equipped with wire dividers (adjustable position) and perimetral support
- nozzles with support for the glassware neck
- suitable for trolleys CLB210 / CLB310 / CLB510
- made of stainless steel



Machines

GW6010L	GW6010LX	GW6010T	GW6010TM	GW7010
GW7010M	GW7010T	GW7010TM		

INS12U4180DVR (art. 904892)

UNIVERSAL INJECTION TROLLEY WITH 12 POSITIONS

- suitable for washing 12 bottles up to 1 liter or 6 flasks up to 2 liters
- equipped with the following nozzles: 12 x U4180 (180 mm), 6 x U6260 (260 mm)
- equipped with 12 caps for configuration
- equipped with wire dividers (adjustable position) and perimetral support
- nozzles with support for the glassware neck
- made of stainless steel

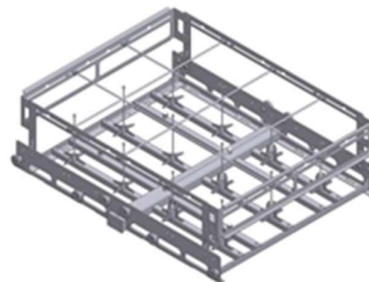

Machines

GW6010ML	GW6010MLX
----------	-----------

INS1548BX (art. 905039)

WASHING INSERT 48 NOZZLES NEUTRAL

- suitable for washing 48 pieces of medium and small size glassware
- to be equipped with 48 nozzles (unused positions must be covered with caps cod. TAPPOUG)
- suitable for trolleys CLB215 / CLB515 / CLB315UNIV
- with perimeter support suitable for treating up to 48 bottles with a maximum diameter of 86 mm.
- made of stainless steel
- for nozzles configuration consult your Area Manager



Machines

GW7015

INS1596U390 (art. 904567)

UNIVERSAL INJECTION TROLLEY WITH 96 POSITIONS

- suitable for washing 96 pieces of medium and small size glassware
- equipped with the following nozzles: 96 x U390 (90 mm)
- nozzles with support for the glassware neck
- suitable for trolleys CLB215 / CLB315 / CLB515 / CLB315UNIV
- made of stainless steel



Machines

GW7015 GW7015T

INS1596U4140 (art. 904695)

UNIVERSAL INJECTION TROLLEY WITH 96 POSITIONS

- suitable for washing 96 pieces of medium and small size glassware
- equipped with the following nozzles: 96 x U4140 (140 mm)
- nozzles with support for the glassware neck
- suitable for trolleys CLB215 / CLB315 / CLB515 / CLB315UNIV
- made of stainless steel



Machines

GW7015 GW7015T

INS20U4180DV (art. 903918)

UNIVERSAL INJECTION TROLLEY WITH 20 POSITIONS

- suitable for washing 20 bottles up to 1 liter
- equipped with the following nozzles: 20 x U4180 (180 mm)
- equipped with wire dividers (adjustable position) and perimetral support
- nozzles with support for the glassware neck
- suitable for trolleys CLB210 / CLB310 / CLB510
- made of stainless steel



Machines

GW6010L GW6010LX GW6010T GW6010TM GW7010
GW7010M GW7010T GW7010TM

INS20U4180DVR (art. 904905)

UNIVERSAL INJECTION TROLLEY WITH 20 POSITIONS

- suitable for washing 20 bottles up to 1 liter
- equipped with the following nozzles: 20 x U4180 (180 mm)
- equipped with wire dividers (adjustable position) and perimetral support
- nozzles with support for the glassware neck
- made of stainless steel



Machines

GW6010ML GW6010MLX

INS28U4140 (art. 904276)

UNIVERSAL INJECTION TROLLEY WITH 28 POSITIONS

- suitable for washing 28 pieces of medium and small size glassware
- equipped with the following nozzles: 28 x U4140 (140 mm)
- nozzles with support for the glassware neck
- suitable for trolleys CLB210 / CLB310 / CLB510
- made of stainless steel



Machines

GW6010L GW6010T GW6010TM GW7010 GW7010M
 GW7010T GW7010TM

INS28U4140R (art. 904893)

UNIVERSAL INJECTION TROLLEY WITH 28 POSITIONS

- suitable for washing 28 pieces of medium and small size glassware
- equipped with the following nozzles: 28 x U4140 (140 mm)
- nozzles with support for the glassware neck
- made of stainless steel

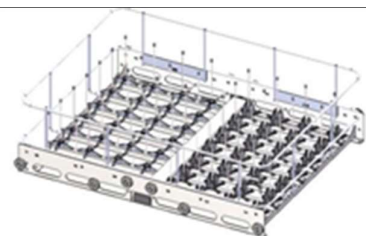

Machines

GW6010ML GW6010MLX

INS28U6260 (art. 903546)

UNIVERSAL INJECTION TROLLEY WITH 28 POSITIONS

- suitable for washing 28 pieces of medium size glassware
- equipped with the following nozzles: 28 x U6260 (260 mm)
- nozzles with support for the glassware neck
- suitable for trolleys CLB210 / CLB310 / CLB510
- made of stainless steel



Machines

GW6010L	GW6010LX	GW6010T	GW6010TM	GW7010
GW7010M	GW7010T	GW7010TM		

INS28U6260R (art. 904894)

UNIVERSAL INJECTION TROLLEY WITH 28 POSITIONS

- suitable for washing 28 pieces of medium size glassware
- equipped with the following nozzles: 28 x U6260 (260 mm)
- nozzles with support for the glassware neck
- made of stainless steel



Machines

GW6010ML	GW6010MLX
----------	-----------

INS42U4180 (art. 904096)

UNIVERSAL INJECTION TROLLEY WITH 42 POSITIONS

- suitable for washing 42 pieces of medium and small size glassware
- equipped with the following nozzles: 42 x U4180 (180 mm)
- nozzles with support for the glassware neck
- suitable for trolleys CLB210 / CLB310 / CLB510
- made of stainless steel



Machines

GW6010L	GW6010LX	GW6010T	GW6010TM	GW7010
GW7010M	GW7010T	GW7010TM		

INS42U4180R (art. 904897)

UNIVERSAL INJECTION TROLLEY WITH 42 POSITIONS SUITABLE FOR SINGLE DOOR MACHINES SERIES “L”

- suitable for washing 42 pieces of medium and small size glassware
- equipped with the following nozzles: 42 x U4180 (180 mm)
- nozzles with support for the glassware neck
- made of stainless steel



Machines

GW6010ML GW6010MLX

INS56BX (art. 904575)

UNIVERSAL INJECTION TROLLEY WITH 56 POSITIONS

- suitable for washing 56 pieces of medium and small size glassware
- to be equipped with 56 nozzles (unused positions must be covered with caps cod. TAPPOUG)
- suitable for trolleys CLB210 / CLB310 / CLB510
- made of stainless steel
- for nozzles configuration consult your Area Manager



Machines

GW6010L GW6010LX GW6010T GW6010TM GW7010
 GW7010M GW7010T GW7010TM

INS56BXR (art. 904895)

UNIVERSAL INJECTION TROLLEY WITH 56 POSITIONS

- suitable for washing 56 pieces of medium and small size glassware
- to be equipped with 56 nozzles (unused positions must be covered with caps cod. TAPPOUG)
- made of stainless steel
- for nozzles configuration consult your Area Manager

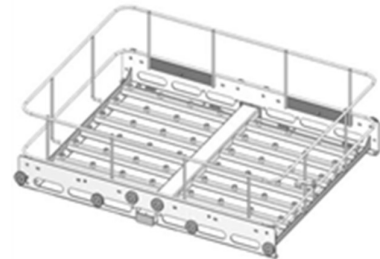

Machines

GW6010ML GW6010MLX

INS56U390 (art. 903547)

UNIVERSAL INJECTION TROLLEY WITH 56 POSITIONS

- suitable for washing 56 pieces of medium and small size glassware
- equipped with the following nozzles: 56 x U390 (90 mm)
- nozzles with support for the glassware neck
- suitable for trolleys CLB210 / CLB310 / CLB510
- made of stainless steel



Machines

GW6010L	GW6010LX	GW6010T	GW6010TM	GW7010
GW7010M	GW7010T	GW7010TM		

INS56U390R (art. 904904)

UNIVERSAL INJECTION TROLLEY WITH 56 POSITIONS

- suitable for washing 56 pieces of medium and small size glassware
- equipped with the following nozzles: 56 x U390 (90 mm)
- nozzles with support for the glassware neck
- made of stainless steel

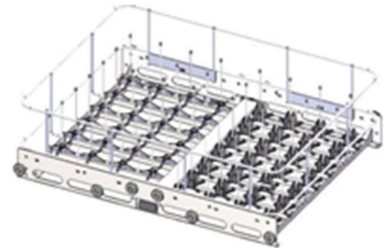

Machines

GW6010ML	GW6010MLX
----------	-----------

INS56U4140 (art. 903543)

UNIVERSAL INJECTION TROLLEY WITH 56 POSITIONS

- suitable for washing 56 pieces of medium and small size glassware
- equipped with the following nozzles: 56 x U4140 (140 mm)
- nozzles with support for the glassware neck
- suitable for trolleys CLB210 / CLB310 / CLB510
- made of stainless steel



Machines

GW6010L	GW6010LX	GW6010T	GW6010TM	GW7010
GW7010M	GW7010T	GW7010TM		

INS56U4140R (art. 904898)

UNIVERSAL INJECTION TROLLEY WITH 56 POSITIONS

- suitable for washing 56 pieces of medium and small size glassware
- equipped with the following nozzles: 56 x U4140 (140 mm)
- nozzles with support for the glassware neck
- made of stainless steel



Machines

GW6010ML GW6010MLX

INS56U4180 (art. 903544)

UNIVERSAL INJECTION TROLLEY WITH 56 POSITIONS

- suitable for washing 56 pieces of medium and small size glassware
- equipped with the following nozzles: 56 x U4180 (180 mm)
- nozzles with support for the glassware neck
- suitable for trolleys CLB210 / CLB310 / CLB510
- made of stainless steel



Machines

GW6010L GW6010LX GW6010T GW6010TM GW7010
GW7010M GW7010T GW7010TM

INS56U4180R (art. 904896)

UNIVERSAL INJECTION TROLLEY WITH 56 POSITIONS

- suitable for washing 56 pieces of medium and small size glassware
- equipped with the following nozzles: 56 x U4180 (180 mm)
- nozzles with support for the glassware neck
- made of stainless steel

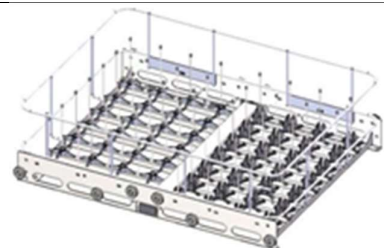

Machines

GW6010ML GW6010MLX

INSM28U4140 (art. 903782)

UNIVERSAL INJECTION TROLLEY WITH 28 POSITIONS - HALF SHELF

- suitable for washing 28 pieces of medium and small size glassware
- equipped with the following nozzles: 28 x U4140 (140 mm)
- nozzles with support for the glassware neck
- suitable for trolleys CLB210 / CLB310 / CLB510
- made of stainless steel

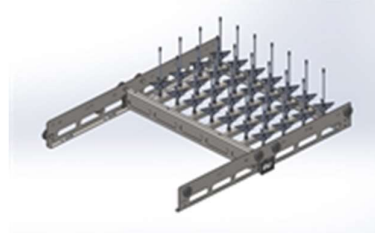

Machines

GW6010L	GW6010LX	GW6010T	GW6010TM	GW7010
GW7010M	GW7010T	GW7010TM		

INSM28U4140R (art. 904902)

UNIVERSAL INJECTION TROLLEY WITH 28 POSITIONS - HALF SHELF

- suitable for washing 28 pieces of medium and small size glassware
- equipped with the following nozzles: 28 x U4140 (140 mm)
- nozzles with support for the glassware neck
- made of stainless steel



Machines

GW6010ML	GW6010MLX
----------	-----------

L680 (art. 900782)

UNIVERSAL INJECTION TROLLEY WITH 76 POSITIONS

- suitable for washing 76 pieces of medium and small dimension glassware
- equipped with the following nozzles: 70 x U4140 (140 mm) + 6 x U3110 (110 mm)
- nozzles with support for the glassware neck adjustable for height
- positioned on the machine levels I or II
- coupled with supports C61 (level I) or C63 (level II)
- made of stainless steel

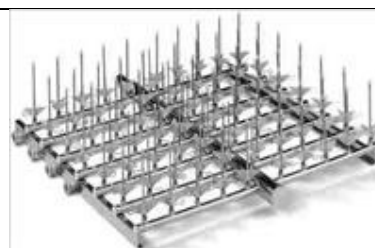

Machines

GW6290DS	GW6290DSG
----------	-----------

L680-LP6 (art. 902616)

MIXED UNIVERSAL INJECTION TROLLEY MAX 75 POSITIONS AND PREDISPOSITION PIPETTES MAX 100 POSITIONS

- suitable for washing 75 pieces of medium and small dimension glassware
- equipped with the following nozzles: 70 x U4140 (140 mm) + 5 x U3110 (110 mm)
- nozzles with support for the glassware neck adjustable for height
- positioned on the machine levels I or II
- coupled with supports C61 (level I) or C63 (level II)
- provided with LP6 adaptor (LP6 not included)
- made of stainless steel



Machines

GW6290DS GW6290DSG

L685 (art. 900743)

UNIVERSAL INJECTION TROLLEY WITH 76 POSITIONS

- suitable for washing 76 pieces of medium and small dimension glassware
- equipped with the following nozzles: 6 x U390 (90 mm), 14 x U3110 (110 mm), 28 x U4140 (140 mm), 14 x U4180 (180 mm), 14 x U6240 (240 mm)
- nozzles with support for the glassware neck adjustable for height
- positioned on the machine levels I or II
- coupled with supports C61 (level I) or C63 (level II)
- made of stainless steel

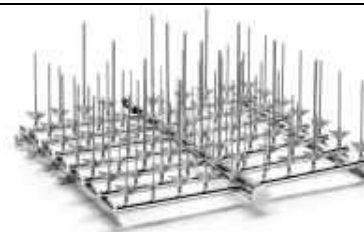

Machines

GW6290DS GW6290DSG

L685-LP6 (art. 902617)

UNIVERSAL INJECTION TROLLEY WITH 75 POSITIONS

- suitable for washing 75 pieces of medium and small dimension glassware
- equipped with the following nozzles: 5 x U390 (90 mm), 14 x U3110 (110 mm), 28 x U4140 (140 mm), 14 x U4180 (180 mm), 14 x U6240 (240 mm)
- nozzles with support for the glassware neck adjustable for height
- positioned on the machine levels I or II
- coupled with supports C61 (level I) or C63 (level II)
- provided with LP6 adaptor
- made of stainless steel

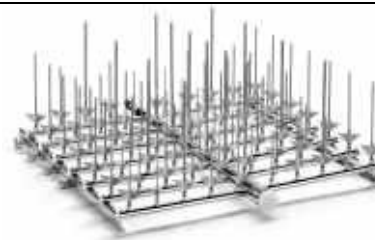

Machines

GW6290DS GW6290DSG

L685-3KP100 (art. 905585)

HIGH CAPACITY INJECTION TROLLEY FOR PIPETTES MAX 300 POSITIONS

- composed of n. 3 x LP6 special collectors (3 x100 pipettes, max height 450 mm, max diameter 8.5 mm)
- positioned on the machine levels I or II
- coupled with supports C61 (level I) or C63 (level II)
- made of stainless steel

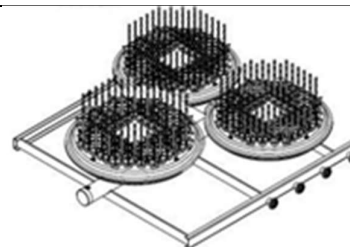

Machines

GW6290DS

GW6290DSG

L690 (art. 900810)

UNIVERSAL INJECTION TROLLEY WITH 86 POSITIONS

- suitable for washing 86 pieces of medium and small dimension glassware
- equipped with the following nozzles: 86 x U3110 (110 mm)
- height adjustable polypropylene base nozzles
- positioned on the machine levels I, II or III
- coupled with supports C61 (level I) or C63 (level II and III)
- made of stainless steel

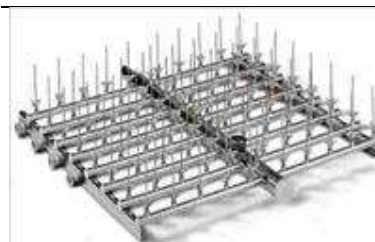

Machines

GW6290DS

GW6290DSG

Pipette injection trolleys *for large dimension machines*

INS152LP (art. 905038)

INJECTION WASHING SHELF FOR HANDLING HUGE QUANTITIES OF PIPETTES

- Injection wash shelf for handling huge quantities of pipettes (no 2 x 104 = 208)
- Equipped with 2 special disc collectors with a special device that allows the treatment of pipettes with max diam 18mm, hmax 550mm
- Suitable for CLB215 / CLB515 / CLB315UNIV trolleys - in which it can be used simultaneously with one other wash shelf only
- Made of stainless steel

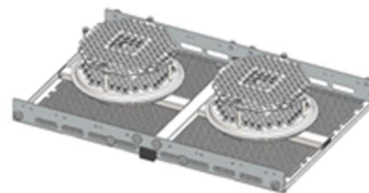

Machines

GW7015 GW7015T

INS2LP (art. 904505)

UNIVERSAL INJECTION TROLLEY FOR PIPETTES

- equipped with 208-position pipette collector
- for standard pipettes max height 560 mm max diameter 18 mm
- suitable for trolleys CLB210 / CLB310 / CLB510
- made of stainless steel

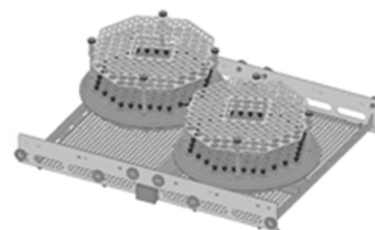

Machines

GW6010L GW6010LX GW6010T GW6010TM GW7010
 GW7010M GW7010T GW7010TM

INS2LPR (art. 904891)

UNIVERSAL INJECTION TROLLEY FOR PIPETTES

- equipped with 208-position pipette collector
- for standard pipettes max height 560 mm max diameter 18 mm
- made of stainless steel

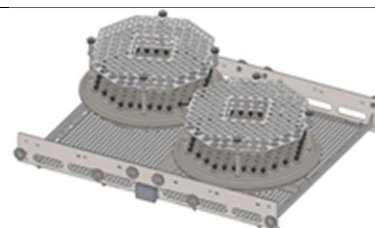

Machines

GW6010ML GW6010MLX

INS56ULB40 (art. 903867)

INJECTION TROLLEY FOR PIPETTE WASHING WITH 56 POSITIONS

- suitable for washing 56 pipettes
- equipped with the following nozzles: 56 x ULB40 for pipettes max height 550 mm
- suitable for trolleys CLB210 / CLB310 / CLB510
- made of stainless steel

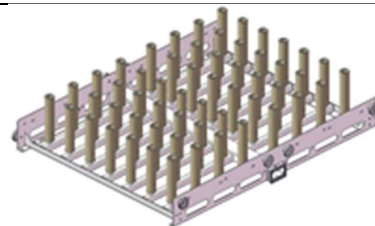

Machines

GW6010L	GW6010LX	GW6010T	GW6010TM	GW7010
GW7010M	GW7010T	GW7010TM		

INS56ULB40R (art. 904899)

INJECTION TROLLEY FOR PIPETTE WASHING WITH 56 POSITIONS

- suitable for washing 56 pipettes
- equipped with the following nozzles: 56 x ULB40 for pipettes max height 550 mm
- made of stainless steel

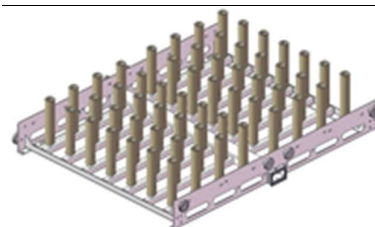

Machines

GW6010ML	GW6010MLX
----------	-----------

LP6 (art. 900981)

PIPETTE ADAPTER FOR MULTI-NOZZLE SYSTEMS

- suitable for 100 standard pipettes max height 450 mm max diameter 8.5 mm
- positioning: hooks on the corresponding hydraulic outlet present on injection systems L680 and L685



Machines

GW6290DS	GW6290DSG
----------	-----------

Mixed injection trolleys (pipette + narrow neck) *for large dimension machines*

INKLP28U4140R (art. 904890)

INSERT FOR MEDIUM-SMALL GLASSWARE WASHING

- Bi-zone insert for the simultaneous washing of medium-small glassware and pipettes / vials
- equipped with the following nozzles: 28 x U4140 (140 mm) for washing the glassware in the first area
- special collector in the second area
- equipped with half collector type LP70 for pipettes with relative half disc support, for the treatment of no 35 standard pipettes hmax 450 mm / max diameter 8.5 mm
- equipped with half collector for vials type KP equipped with no 35 U390 nozzles
- suitable for GW6010ML / MLX series
- complete with 28 plastic caps for closing unused holes
- made of stainless steel

Machines

GW6010ML GW6010MLX

INS15LP24BX (art. 904607)

UNIVERSAL INJECTION TROLLEY WITH 24 POSITIONS WITH COLLECTOR FOR PIPETTES

- equipped with 70-position pipette collector
- for standard pipettes max height 450 mm max diameter 8.5 mm
- to be equipped with 24 nozzles (unused positions must be covered with caps cod. TAPPOUG)
- suitable for trolleys CLB215 / CLB315 / CLB515
- made of stainless steel
- for nozzles configuration consult your Area Manager

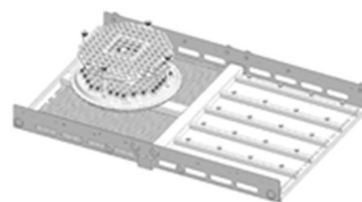

Machines

GW7015 GW7015T

INSLP28U4140 (art. 903780)

UNIVERSAL INJECTION TROLLEY WITH 28 POSITIONS WITH COLLECTOR FOR PIPETTES

- equipped with the following nozzles: 28 x U4140 (140 mm)
- equipped with 70-position pipette collector for standard pipettes max height 450 mm max diameter 8.5 mm
- suitable for trolleys CLB210 / CLB310 / CLB510
- made of stainless steel



Machines

GW6010L	GW6010LX	GW6010T	GW6010TM	GW7010
GW7010M	GW7010T	GW7010TM		

INSLP28U4140R (art. 904901)

BI-ZONE INSERT FOR SIMULTANEOUS WASHING OF MEDIUM-SMALL GLASSWARE AND PIPETTES

- Bi-zone insert for the simultaneous washing of medium-small glassware and pipettes
- equipped with the following nozzles: 28 x U4140 (140 mm) for washing the glassware in the first area
- equipped with LP70 pipette collector with relative disk support in the second zone
- for the treatment of n. 70 standard pipettes with special device that allows the treatment of pipettes with max diam 18mm, hmax 550mm
- complete with 28 plastic caps for closing unused holes
- suitable for GW6010ML / MLX series machines
- made of stainless steel

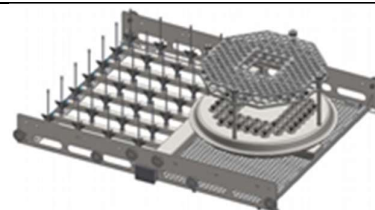

Machines

GW6010ML	GW6010MLX
----------	-----------

INSPIPE31R (art. 905037)

INSERT WITH TUBES WASHING SUPPORT

- The product consists of:
- n° 1 shelf with manifold and support for pipes
- n° 1 manifold with 16 nozzles with silicone caps Ø6mm holes
- n° 1 manifold with 12 injector nozzles for pipes and 3 threaded fittings 3/8"
- to be positioned only on the first (lower) level of the machine with guides in the chamber
- Configuration type and maximum processable load:
- max n° 16 tubes external diameter min 6 mm / max 8 mm max length 30 cm
- max n° 4 tubes internal Ø 10mm max length 150 cm
- max n° 4 pipes internal Ø 14mm max length 150 cm
- max n° 4 pipes internal Ø 12mm max length 150 cm
- max n° 3 pipes stainless steel, 3/8 "connection 150 cm length
- For GW6010ML/GW6010MLX machines



Machines

GW6010ML

GW6010MLX

Injection trolleys for large glassware

C636-I (art. 903569)

INJECTION TROLLEY FOR BOTTLES WITH DRYING SYSTEM

- suitable for washing and drying n. 36 narrow-neck bottles wide 250-1000 ml
- bottle maximum dimension - diameter: 90 mm, height: 285 mm
- equipped with the following nozzles: 36 x U6240 (240 mm)
- positioned on the lower level
- made of stainless steel



Machines

GW6290DS GW6290DSG

C624-I (art. 905647)

INJECTION TROLLEY WITH 24 POSITIONS FOR BOTTLES, WITH DRYING SYSTEM

- suitable for washing and drying n. 20 bottles or beakers with a maximum diameter of 110mm and 4 bottles or beakers with a maximum diameter of 140mm.
- equipped with the following nozzles: 24 x U6240 (240 mm)
- positioned on the lower level
- made of stainless steel



Machines

GW6290DS GW6290DSG

C636-S (art. 903568)

INJECTION TROLLEY FOR BOTTLES WITH DRYING SYSTEM

- suitable for washing and drying n. 36 narrow-neck bottles wide 250-1000 ml
- bottle maximum dimension - diameter: 90 mm, height: 285 mm
- equipped with the following nozzles: 36 x U6240 (240 mm)
- positioned on the upper level
- made of stainless steel



Machines

GW6290DS GW6290DSG

C65-I (art. 901756)

LOWER INJECTION TROLLEY FOR LARGE BOTTLES

- lower washing and drying injection trolley for n. 9 large bottles
- bottle maximum dimensions - diameter: 175 mm, height: 285 mm
- made of stainless steel

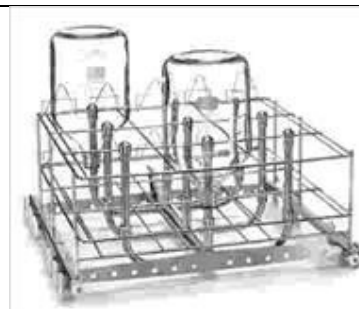

Machines

GW6290DS GW6290DSG

C65-S (art. 901758)

UPPER INJECTION TROLLEY FOR LARGE BOTTLES

- upper washing and drying injection trolley for n. 9 large bottles
- bottle maximum dimensions - diameter: 175 mm, height: 285 mm
- made of stainless steel

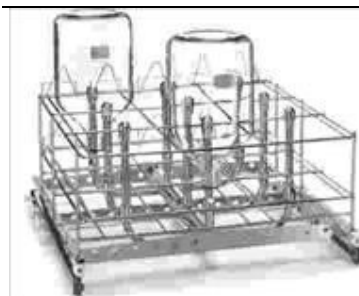

Machines

GW6290DS GW6290DSG

COCI42 (art. 954384)

COLLECTOR FOR GRADUATED CYLINDERS

- suitable for washing 4 cylinders from 500 ml to 2000 ml (diameter max: 85 mm, height min: 360 mm, height max: 568 mm)
- equipped with the following nozzles: 4 x U6370 (370 mm)
- rubberised supports to protect the edges of the cylinder necks
- use on trolleys LCB6010
- overall dimension equal to half of the washing surface

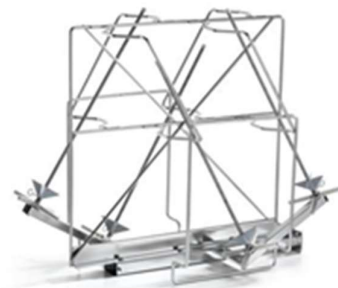

Machines

GW6010L GW6010LX GW6010T GW6010TM GW7010
 GW7010M GW7010T GW7010TM

COCI42R (art. 955920)

GRADUATED CYLINDERS INSERT

- To combine with LCB6010R
- Equipped with n° 4 U6370 nozzles with support and n° 4 rubber supports 100 mm



Machines

GW6010ML GW6010MLX

COCI9215 (art. 955057)

COLLECTOR FOR GRADUATED CYLINDERS

- suitable for washing 9 cylinders from 500 ml to 2000 ml (diameter max: 85 mm, height min: 360 mm, height max: 568 mm)
- equipped with the following nozzles: 9 x U6370 (370 mm)
- rubberised supports to protect the edges of the cylinder necks
- use on trolleys LCB7015
- overall dimension equal to half of the washing surface



Machines

GW7015 GW7015T

INS1515BX (art. 904887)

MODULAR INJECTION WASHING SHELF

- Modular injection washing shelf
- It can be equipped with a maximum of 15 injectors, even different from each other, for washing glassware of various sizes
- settle the insert with the desired nozzles (the uncovered positions must be closed by a TAPPOUG cap)
- perimetral frame adjustable in height and adjustable dividers for the best containment of glassware
- suitable for CLB215 / CLB515 / CLB315UNIV trolleys
- made of stainless steel
- to configure nozzles ask the Area Manager



Machines

GW7015 GW7015T

INS1528BX (art. 904605)

UNIVERSAL INJECTION TROLLEY WITH 28 POSITIONS

- suitable for washing 28 pieces of medium and small size glassware
- to be equipped with 28 nozzles (unused positions must be covered with caps cod. TAPPOUG)
- suitable for trolleys CLB215 / CLB315 / CLB515 and CLB315UNIV
- made of stainless steel
- for nozzles configuration consult your Area Manager

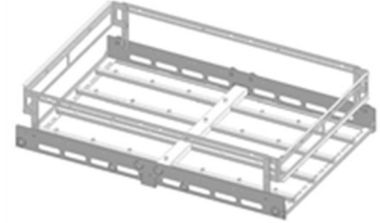

Machines

GW7015 GW7015T

INS28BX (art. 905134)

MODULAR INJECTION WASHING SHELF 28 POSITIONS

- Modular injection washing shelf
- It can be equipped with a maximum of 28 injectors, even different from each other, for washing glassware of various sizes
- Settle the insert with the desired nozzles (the uncovered positions must be closed by a cap code TAPPOUG)
- Suitable for CLB210/310/510/CLB310UNIV trolleys
- Made of stainless steel
- For the nozzle configuration ask the Area Manager

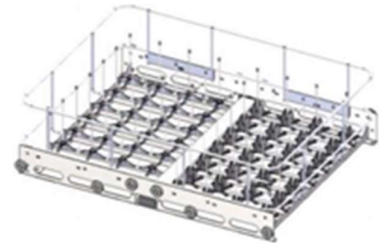

Machines

GW6010L GW6010LX GW6010T GW6010TM GW7010
GW7010M GW7010T GW7010TM

INS28BXR (art. 905133)

MODULAR INJECTION WASHING SHELF 28 POSITIONS

- Modular injection washing shelf
- It can be equipped with a maximum of 28 injectors, even different from each other, for washing glassware of various sizes
- Settle the insert with the desired nozzles (the uncovered positions must be closed by a cap code TAPPOUG)
- Suitable for machines with guides into the chamber GW6010ML / GW6010MLX
- Made of stainless steel
- For the nozzle configuration ask the Area Manager



Machines

GW6010ML GW6010MLX

INSLB4R (art. 905055)

WASHING INSERT FOR LARGE BOTTLES

- washing insert for large bottles
- available for machines of the GW6010ML and GW6010MLX series, to be used at the first level only
- suitable for washing a maximum of 3 bottles diam 250mm and h 500mm 13 liters, or for a maximum of 4 bottles diam 230 mm and h 500 mm 10 liters
- equipped with 4 ULB6140 nozzles, 4 bottle holders 100 mm, height-adjustable perimeter frame and series of adjustable dividers
- made of stainless steel

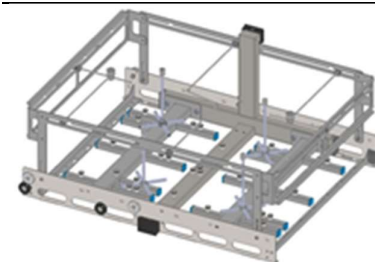

Machines

GW6010ML GW6010MLX

LM6-5 (art. 904766)

TROLLEY FOR LARGE BOTTLES OR DRUMS

- injection trolley for washing and drying large bottles and/or drums
- can be modified to wash up to 5 large bottles/drums (from 1 to 5 nozzles)
- drum maximum dimensions LxDxH: 600 x 600 x 800 mm
- supports can be adjusted according to the height of the bottle/drum
- made of stainless steel



Machines

GW6290DS GW6290DSG

L685CIL (art. 903204)

INJECTION TROLLEY FOR 12 GRADUATED CYLINDERS

- suitable for washing and drying 12 cylinders from 500 ml to 2000 ml
- equipped with 12 special nozzles with spiral spraying effect for washing the edges and the bottom
- 6 nozzles 390 mm long and 6 nozzles 440 mm long
- possible configurations: 12 x 1000 ml cylinders or 3 x 2000 ml cylinders + 6 x 1000 ml cylinders + 3 x 500 ml cylinders or 6x 1000 ml cylinders + 6 x 1000 ml cylinders
- removable supports allow different load configurations guarantying considerable flexibility
- optimum inclination in order to avoid stagnation of water on the base and inside the cylinders
- positioning in the washer on the first level and occupies 2/3 of the washing chamber
- made of stainless steel

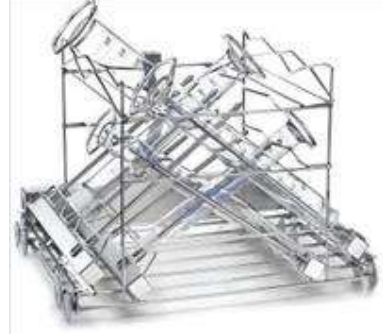

Machines

GW6290DS

GW6290DSG

L690CIL (art. 903715)

INJECTION TROLLEY FOR 36 GRADUATED CYLINDERS

- suitable for washing and drying 36 cylinders from 350 to 700 mm with maximum diameter 85 mm
- equipped with the following nozzles: 36 x U6370 (370 mm)
- positioning in the washer on the first level
- made of stainless steel

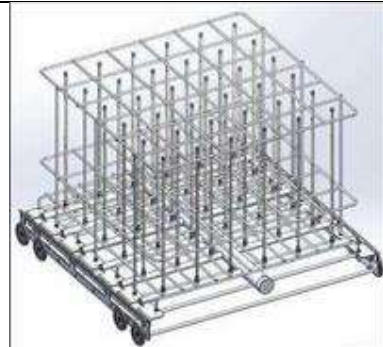

Machines

GW6290DS

GW6290DSG

Injection trolleys for vials and conical centrifuge test tubes *for large dimension machines*

INSKP200 (art. 904232)

INJECTION TROLLEY FOR TEST TUBES

- suitable for internal washing of vials, conical centrifuge tubes, centrifuge rotors
- equipped with the following nozzles: 208 x U390 (90 mm)
- suitable for trolleys CLB210 / CLB310 / CLB510
- made of stainless steel



Machines

GW6010L	GW6010LX	GW6010T	GW6010TM	GW7010
GW7010M	GW7010T	GW7010TM		

INSKP200R (art. 904900)

INJECTION TROLLEY FOR TEST TUBES

- suitable for internal washing of vials, conical centrifuge tubes, centrifuge rotors
- equipped with the following nozzles: 208 x U390 (90 mm)
- made of stainless steel



Machines

GW6010ML	GW6010MLX
----------	-----------

L6208 (art. 905162)

INJECTION INSERT 208 POSITIONS

- suitable for washing 208 vials, test tubes / small glassware
- equipped with the following nozzles: 208 x U390 (90 mm)
- height adjustable polypropylene base nozzles
- positioned on the machine GW6290DS (or compatible predecessors) at levels I, II or III
- coupled with supports C61 (level I) or C63 (level II and III)
- made of stainless steel

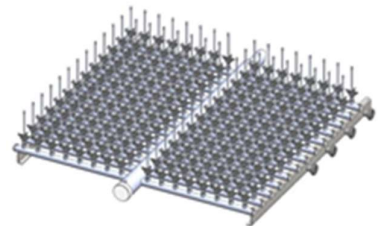

Machines

GW6290DS	GW6290DSG
----------	-----------

Transport systems

DIS-WD5 (art. 902411)

RELEASE TROLLEY FOR 60-90 CM MACHINES WITH PLINTH

- for loading and unloading of trolleys
- equipped with 4 pivoting and 2 lockable wheels
- equipped with double handle for movement
- lower level for holding supports or other trolleys
- system for collection of liquid residue as required by ISO EN 15883-1 in force
- made of stainless steel



Machines

GW0260-00-00J	GW0260-S0-00J	GW1260-00-000	GW1260-S0-000	GW1260-SC-000
GW3060BX	GW3060BXA	GW3060BXC	GW3060BXCA	GW3060P
GW3060PA	GW3060S	GW3060SA	GW3060SC	GW3060SCA
GW4090	GW4090A	GW4090BXC	GW4090BXCA	GW4090BXP
GW4090C	GW4090CA	GW4090P	GW4090PA	GW4260-00-000
GW4260-S0-000	GW4260-SC-000	GW4290-00-000	GW4290-SC-000	

DIS-WD6010 (art. 903455)

RELEASE TROLLEY FOR DOUBLE DOOR MACHINES

- release trolley with safety block system to load/unload washing racks into the washer disinfecter
- diamond-shaped basin for collecting liquid dripping from load material
- equipped with 4 rotating and lockable wheels
- equipped with ergonomic handle for transportation
- safety system for locking washing trolleys
- system for collection of liquid residue as required by ISO EN 15883-1 in force
- made of AISI 304 stainless steel



Machines

GW6010L	GW6010LX	GW6010ML	GW6010MLX	GW6010T
GW6010TM				