

Agilent Inert Plus GC/MS System with HydroInert Source

Applying H₂ carrier gas to real-world GC/MS analyses

Introduction

With increased price and pressure on the helium (He) market, laboratories are looking for a more sustainable alternative to helium and exploring the option of hydrogen (H₂) carrier gas. The benefits of hydrogen in gas chromatography (GC) are widely accepted, as it can be generated in the lab in a cost-effective manner and produces fast chromatography and higher sample throughput. Since hydrogen is a reactive gas, hydrogenation and dechlorination reactions can and do occur in the mass spectrometer electron ionization (EI) source. These reactions can make applying hydrogen carrier gas to many applications difficult. A newly designed extractor source for the Agilent 5977B Inert Plus GC/MSD and Agilent 7000D/E Inert Plus triple quadrupole GC/MS systems address these hydrogen-related issues and help improve performance with hydrogen carrier gas in GC/MS and GC/MS/MS. The Agilent HydroInert source with H₂ carrier gas retains mass spectral fidelity and can allow users to continue to use existing helium-based mass spectral libraries.

Transitioning from helium to hydrogen

Considerations for applying H₂ to GC/MS analyses have been discussed in previous literature.¹ These considerations, especially the focus on GC parameters for optimal separation, remain valid with the Hydrolnert source for Inert Plus mass spectrometer systems. While helium is the best carrier gas for GC/MS, the Hydrolnert source was developed to work with hydrogen carrier gas, which is the best alternative when helium is not available.

Some of the considerations are summarized in a shortened list below:

- It is highly recommended that stainless steel tubing be used with H₂. If only copper tubing is available, install fresh copper lines. A stainless steel installation kit of fittings and tubing is available under part number 19199S.
- Always use gas filters, especially with H₂ generators. The recommendation is to install an Agilent big universal trap (for moisture, O₂, and hydrocarbons) for H₂ (part number RMSH-2-SS) and an Agilent Gas Clean purifier for carrier gas (part number CP17976 for the kit including a base, or part number CP17973 for a replacement carrier gas filter if you already have the base).
- Decrease inlet temperature when working with sensitive compounds, or use cold splitless injection with multimode inlet, where possible.

- Hydrogen viscosity is lower than helium, causing lower inlet pressures. It is advisable to at least:
 - Change column dimensions, or
 - Increase the carrier gas flow rate
- Optimal carrier gas flows depend on the pump, as pumping capacity for hydrogen is lower than helium.
 - Optimal range: 0.5 to 1.0 mL/min
 - Maximum recommended flow rate for turbo pump: 2.0 mL/min
- Use constant flow methods.
- For GC/MS/MS systems running hydrogen, no quench gas (helium) is used. Please remove the helium plumbing from the back of the electronics pressure control module (EPC) and set the quench gas to 0.00 mL/min in any GC/MS/MS method.

Changes will be required in most cases, and it is necessary to allot time for necessary updates to standard operating procedures (SOPs) and method validation.

Hydrolnert source

The Hydrolnert source, shown in Figure 1, is a novel source based on the Agilent extractor source design. The Hydrolnert source is an easy conversion from the existing EI extractor or EI Inert Plus sources in both the single quadrupole (Agilent 5977B or 5977C GC/MSD) and the triple quadrupole (Agilent 7000D or 7000E triple quadrupole GC/MS) systems. Do not mix the Hydrolnert source parts with the extractor source parts; this can cause unexpected and unwanted results, especially when using hydrogen carrier gas.

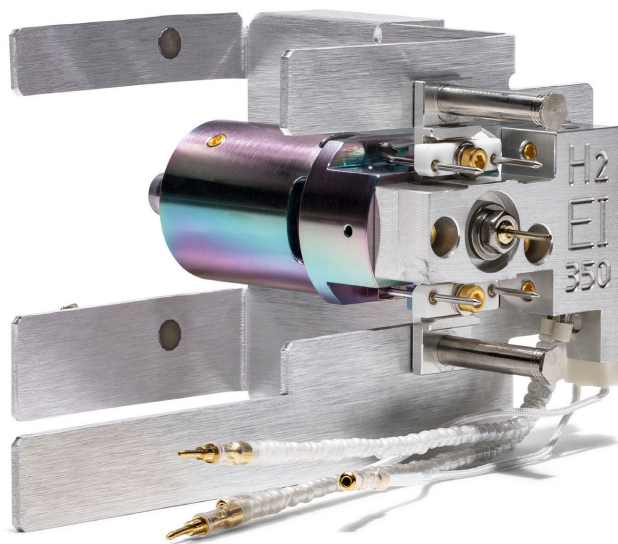

Figure 1. Agilent Hydrolnert source.

Usually, there would be a note about hydrogenation or dechlorination of certain compound classes when using H₂ with GC/MS systems, along with a discussion about the need to build internal compound libraries or understanding that library match scores with the NIST or other helium-based libraries may not match well with hydrogen mass spectra. However, the Hydrolnert source is more inert to H₂, and the mass spectra retain their normal characteristics observed in He mass spectra.

Here is a primary example of the benefits of the Hydrolnert source with nitrobenzene. In an experiment with an extractor source with a 3 mm extraction lens, hydrogen was used as the carrier gas for testing semivolatile organic compound (SVOC) analysis. Nitrobenzene was one of the compounds in the mixture (part number SVM-122-1). Nitro compounds are known to be susceptible to hydrogenation when in the presence of heat, hydrogen, and metal surfaces; all these factors are present in the extractor source. Hydrogenation of nitrobenzene (molecular weight (MW) 123 *m/z*) will form aniline (MW 93 *m/z*). When reviewing the mass spectrum under the total ion chromatogram (TIC) peak for the extractor source and H₂ carrier gas, the mass spectrum in Figure 2A was observed. There is a large abundance of 93 *m/z* and low 123 *m/z*, indicating conversion of nitrobenzene to aniline in the source; this is confirmed to occur in the source because the mass spectrum is observed at the retention time of nitrobenzene, which is well separated from aniline.

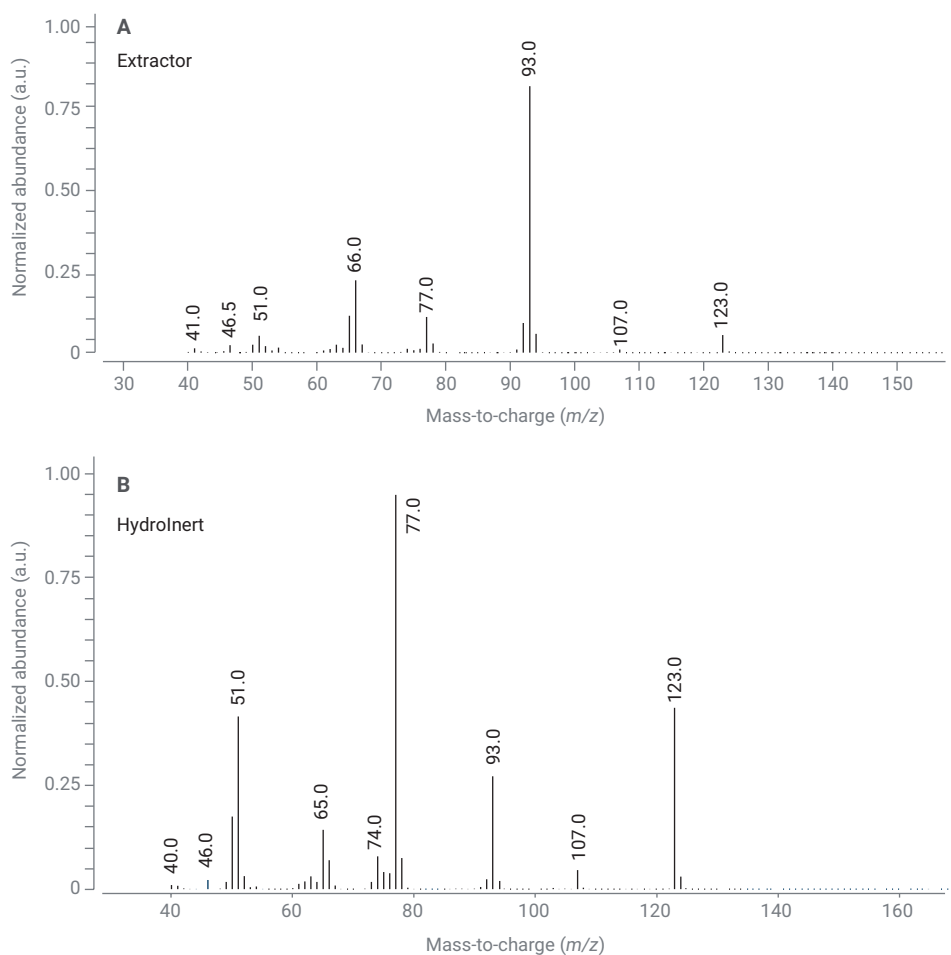

Figure 2. Mass spectra for peak eluting at nitrobenzene retention time with hydrogen carrier gas in (A) extractor source with 3 mm extraction lens showing hydrogenation to aniline with the abundant 93 *m/z* ion and (B) Agilent Hydrolnert source, showing an improved mass spectrum that correlates to nitrobenzene.

Comparatively, the same mixture containing nitrobenzene was tested on a Hydrolnert source (with a 9 mm extraction lens), where we observe the expected distribution of 123 *m/z* and 93 *m/z* in the mass spectrum (Figure 2B), indicating the nitrobenzene is retained in the source and not converted to aniline. This comparison can also be reviewed in the extracted

ion chromatograms (EICs) shown in Figures 3A (the extractor source conversion) and 3B (for Hydrolnert source retention of nitrobenzene), where we observe an improved 123/93 ratio using the Hydrolnert source, while the extractor source EIC overlay shows significant conversion to 93 *m/z* and significant tailing.

Mass spectral fidelity examples

Nitrobenzene is one example of mass spectral fidelity occurring with H₂ carrier gas and the Hydrolnert source. Other nitro compounds can also have hydrogenation issues in the presence of H₂, whether the compound is a pesticide, SVOC, or other compound class. Chlorinated compounds can also dechlorinate in the presence of H₂ carrier gas and metal or other active sites; dichlorodiphenyltrichloroethane (DDT) is a common compound that has breakdown issues in GC inlets due to heat and active sites, like metal, but can also be affected by dechlorination in a source in the presence of hydrogen. DDT was analyzed by He carrier gas and then with H₂ carrier gas using the extractor source and a pair of columns, to match retention times generated from the He carrier gas method. Commonly, two Agilent J&W HP-5ms Ultra Inert GC columns, 15 m × 0.25 mm, 0.25 μm, are used for pesticide analysis. For hydrogen, the columns were changed to two Agilent J&W HP-5ms Ultra Inert GC columns, 20 m × 0.18 mm, 0.18 μm, to match the retention times and avoid having to reset many retention times for a method containing hundreds of pesticides. Based on the helium results, DDT eluted at 13.04 minutes, while dichlorodiphenyldichloroethylene (DDE) and dichlorodiphenyldichloroethane (DDD) eluted earlier at 12.44 and 12.88 minutes, respectively. Looking at the results for H₂ carrier gas and the extractor source at 13.04 minutes, DDD was identified instead of DDT, as indicated in Table 1. With the Hydrolnert source and H₂ carrier gas, DDT was accurately identified at 13.04 minutes, with a library match score of 85 (compared to NIST17.L library). This misidentification at 13.04 minutes for the extractor source (and hydrogen carrier gas) occurred across multiple

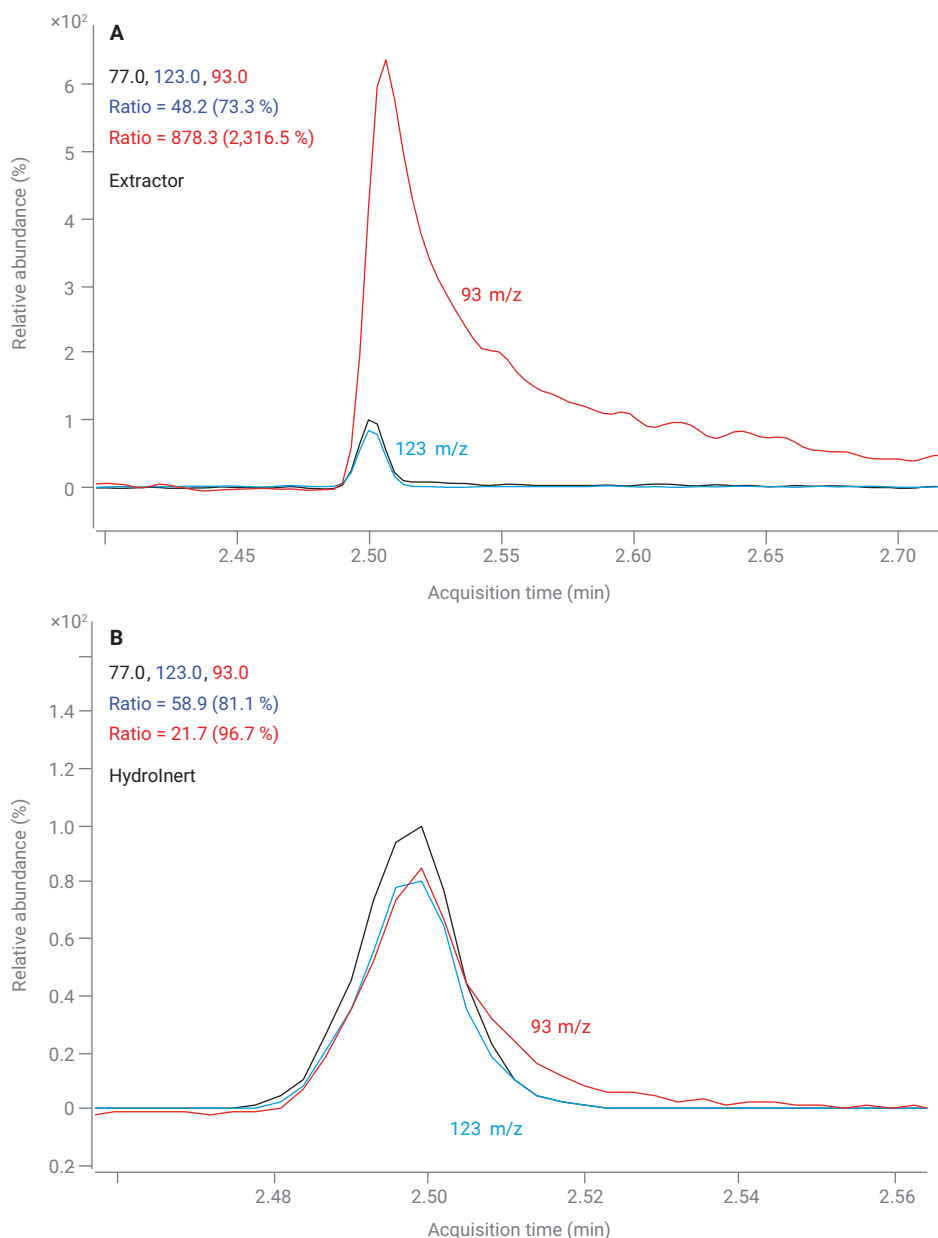

Figure 3. EICs of nitrobenzene with hydrogen carrier gas in (A) extractor source with 3 mm extraction lens, showing hydrogenation to aniline with the abundant 93 m/z ion and (B) Agilent Hydrolnert source, showing an improved 123 versus 93 m/z ratio.

Table 1. Comparison of extractor and Agilent Hydrolnert sources when using H₂ carrier gas for identification of DDT and DDT breakdown products.

Source with H ₂ Carrier Gas	Retention Time (min)	Identified Compound	Library Match Score
Extractor	13.04	DDD	79
Hydrolnert	13.04	DDT	85

runs, indicating that DDT was being dechlorinated in the source to DDD. In both Hydrolnert and extractor source systems, DDE and DDD were also identified at their respective retention times (12.44 and 12.88 minutes), showing that there was <10% DDT breakdown occurring in the inlet as well. The inlet breakdown was not the focus of this testing set; optimizing the injection parameters and liner can decrease the DDT breakdown, as could lowering inlet temperatures or using cold splitless injection with a multimode inlet.

Another chlorinated compound example can be observed with heptachlor. Using the same experimental design as nitrobenzene, an extractor source with a 3 mm extraction lens was installed in a GC/MS single quadrupole instrument with H₂ carrier gas, which is the recommended extraction lens for pesticide analysis with He. A mixture of pesticides (part number PSM-105-A), including heptachlor, was diluted to 10 ng/μL and a set of deuterated polycyclic aromatic hydrocarbons (PAHs) was added as internal standards. The deconvoluted mass spectrum of heptachlor is shown in Figure 4A with a head-to-tail comparison with the NIST17.L library mass spectrum of heptachlor. The most abundant ions should be 272, 274, 270, 100, and 65 m/z, but Figure 4A and Figure 5A display a significant increase in ion abundance for the ions around 235 and 237 m/z, causing them to be in the top five most abundance ions, while the 272 and 274 m/z are suppressed. Only 272 m/z is found in the top five most abundant EICs, and 165 m/z has significant contribution as an EIC, which should have little-to-no intensity. Also, two of the five EICs, 66 and 272 m/z, have different peak apices than the other three. This swap in higher-abundance regions from the 272 to 235 m/z region, change in the highest abundance ions, and mismatched peak apexes indicates dechlorination

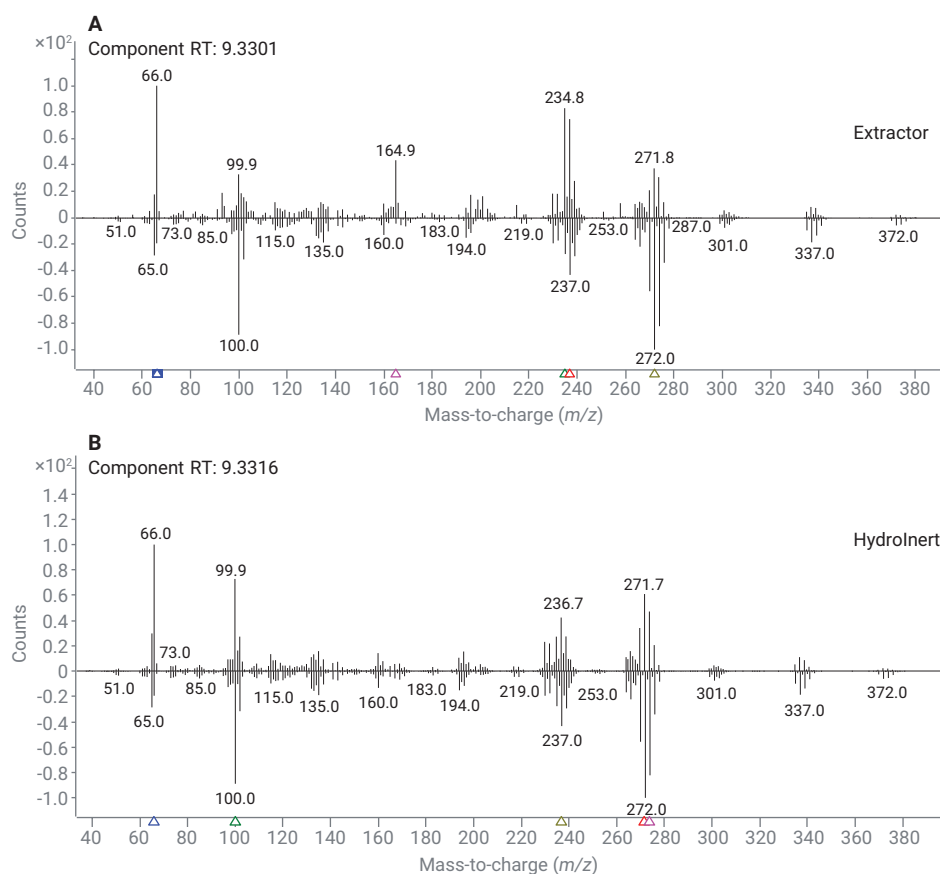

Figure 4. Head-to-tail comparison of deconvoluted mass spectrum (top) to library mass spectrum, NIST17.L (bottom) for heptachlor with H₂ carrier gas and (A) extractor source with 3 mm extraction lens and (B) Agilent Hydrolnert source with 9 mm extraction lens.

reactions occurred in the source. Comparatively, results for H₂ carrier gas and the Hydrolnert source with a 9 mm extraction lens are shown in the extracted mass spectrum in Figure 4B, and the top five abundant EICs in Figure 5B. In Figure 4B, 272 *m/z* region is higher than the 237 *m/z* region, and there is a significant abundance to 100 *m/z*, like the reference library spectrum on the bottom of the head-to-tail comparison, indicating retention of chlorine atoms. Additionally, the top five EICs for the Hydrolnert results have aligned peak apices and include three of the expected ions: 272, 274, and 100 *m/z*; ions 237 and 270 *m/z* are close in abundance with 237 *m/z* slightly taller and edging out 270 *m/z* to reach the top five EICs.

Library match scores examples

Since the Hydrolnert source prevents compound breakdown, hydrogenation, and dechlorination in the presence of hydrogen, libraries of mass spectra collected with helium can be used with the Hydrolnert source and H₂ carrier gas. We completed experiments to evaluate the use of a large general library, such as the NIST library, when using He or H₂ carrier gas with extractor and Hydrolnert sources, with their respective 9 mm extraction lenses, as follows: an extractor source with He carrier gas, an extractor source with H₂ carrier gas, and a Hydrolnert source with H₂ carrier gas. A mixture of SVOCs, pesticides, and fragrance compounds was generated with a set of six deuterated PAHs at 10 ng/μL to run across all three source experiments on an Agilent 8890 GC with a 5977 Inert Plus single quad mass spectrometer in scan mode. The data were loaded into Agilent MassHunter Unknowns Analysis software and a deconvolution method was applied using the NIST17.L library to evaluate library match scores (LMS).

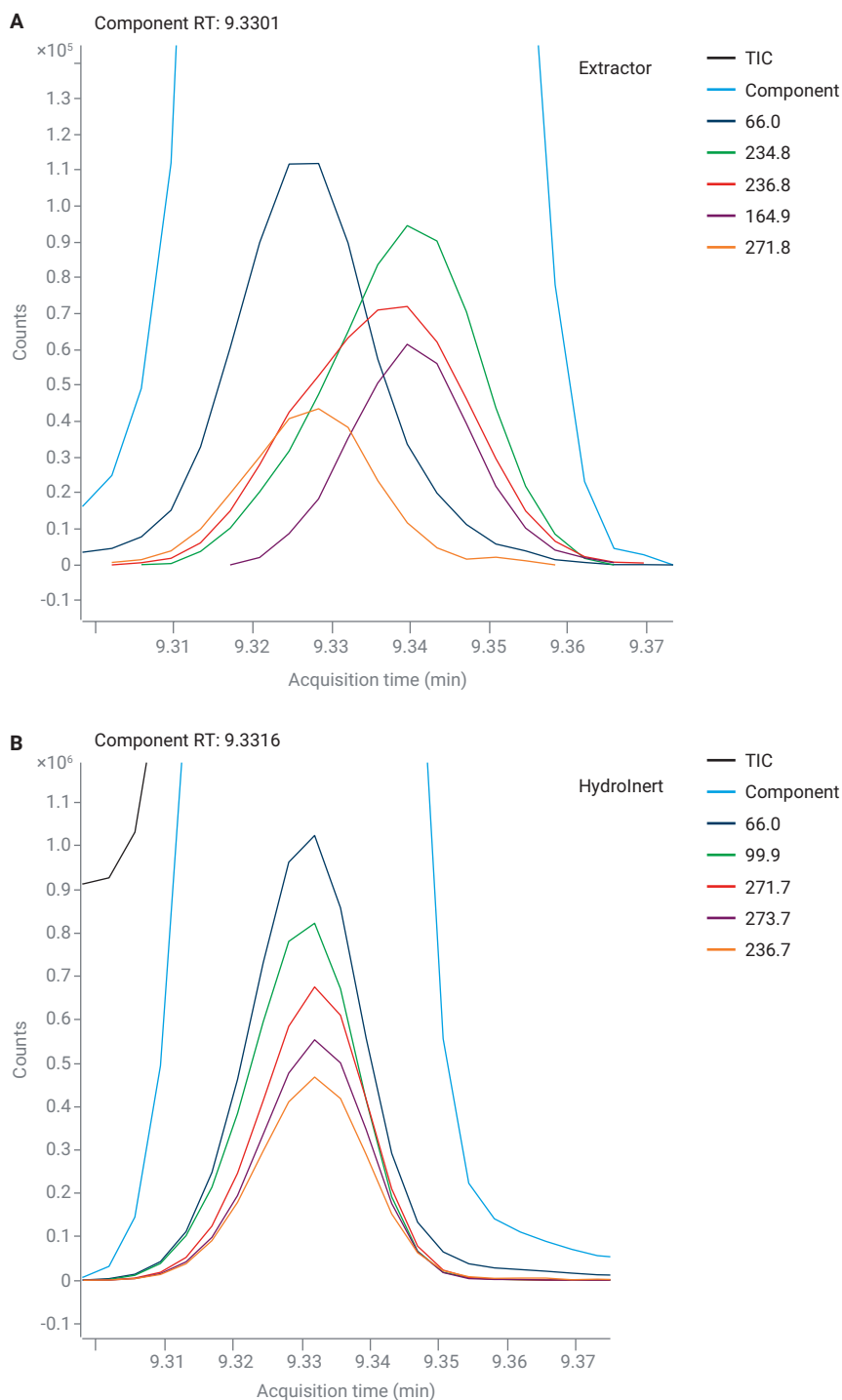

Figure 5. EICs of the top five abundant ions for heptachlor with H₂ carrier gas and (A) extractor source with 3 mm extraction lens and (B) Agilent Hydrolnert source with 9 mm extraction lens.

The helium carrier gas with extractor source LMS values in Table 2 are used as the baseline values to compare to H₂ carrier gas with an extractor source (center column) or the Hydrolnert source (right column). All the LMS values for the Hydrolnert source are within five percentage points of the helium LMS values, where some of the LMS values for the Hydrolnert source with H₂ are better matches to the NIST library, for example 4-nitrophenol and benzidine. Fifteen of the Hydrolnert collected LMS values are within two percentage points of the He collected data and five LMS values for Hydrolnert source are three or more percentage points higher than the He collected LMS values, such as musk ambrette and benzidine. This retention of high LMS values with H₂ carrier gas and Hydrolnert source indicates retention of functional groups and mass spectral fidelity in the source. However, the H₂ carrier gas and extractor source has 10 compounds with LMS values lower by five percentage points or more compared to the H₂ Hydrolnert LMS values. Some LMS values for the extractor source are as low as 70, such as benzidine and benzo(b)fluoranthene, indicating that hydrogenation or other conversions are occurring in the extractor source with H₂ carrier gas. As expected, the chlorinated compounds and nitro compounds were affected by the H₂ carrier gas and extractor source with lower library match scores, including nitrobenzene (80.9 LMS), 4-nitrophenol (83.1 LMS), pentachlorophenol (85.4 LMS), fenitrothion (88.3 LMS), and musk ketone (89.8 LMS). These scores are still relatively high, but as concentrations drop and identifications become more difficult, the conversion of compounds in the source becomes more problematic. In summary, Hydrolnert source with H₂ carrier gas retains mass spectral fidelity and can allow users to continue to use existing He-based mass spectral libraries.

Table 2. Comparison of LMS for a mixture of SVOCs, pesticides, and fragrance compounds using an extractor source with He carrier gas, an extractor source with H₂ carrier gas, and an Agilent Hydrolnert source with H₂ carrier gas.

Analyte	Extractor He LMS	Extractor H ₂ LMS	Hydrolnert H ₂ LMS
Aniline	98.6	92.3	97.7
1,4-dichlorobenzene-d ₄	96.7	94.7	97.5
Nitrobenzene	95.7	80.9	94.3
Benzoic acid	93.3	87.7	97.2
Naphthalene-d ₈	96.9	93.9	97.6
Acenaphthene-d ₁₀	98.3	97.3	97.8
2,4-dinitrophenol	95.6	90.6	94.8
4-nitrophenol	89.5	83.1	94.8
4,6-dinitro-2-methylphenol	94.3	93.6	95.7
Pentachlorophenol	90.7	85.4	89.1
4-aminobiphenyl	96.9	95.8	97.9
Phenanthrene-d ₁₀	97.7	93.3	97.2
Musk ambrette	86.6	86.3	89.5
Fenitrothion	95.6	88.3	97.0
Musk ketone	95.8	89.8	98.2
Benzidine	92.6	70.1	97.5
3,3'-dichlorobenzidine	97.3	89.8	95.3
Chrysene-d ₁₂	96.0	84.8	93.5
Benzo[b]fluoranthene	97.8	70.1	98.4
Benzo[k]fluoranthene	97.8	96.8	98.4
Perylene-d ₁₂	94.4	79.4	93.1

Reduced source cleaning

One of the advantages observed with hydrogen carrier gas is a reduced EI source cleaning. This has been observed when using Agilent Jet Clean self-cleaning ion source, which introduces a low flow of hydrogen into the source during or after analysis.² The reduction of source cleaning is also observed with the Hydrolnert source. A set of experiments was completed to investigate source lifetime using a complex soil matrix and Environmental Protection Agency (EPA) method 8270 target analytes and quality control criteria to evaluate when the GC or MS required maintenance. One set of experiments used He carrier gas with an extractor source and 9 mm extraction lens; the other experiment set used H₂

carrier gas with the Hydrolnert source and 9 mm (Hydrolnert) extraction lens. The He GC/MS system required source cleaning after an average of 365 matrix injections (581 total injections). For the Hydrolnert source, 5,200 matrix injections were completed before the source failed acceptance criteria. The Hydrolnert extraction lens and repeller were replaced and retuned, and the system was able to recover to acceptable performance. At this time, the Hydrolnert extraction lens and repeller are recommended to be replaced if found to be dirty, and method criteria cannot be recovered with GC maintenance. The extraction lens insulator (part number G3870-20445) may also be replaced at the same time, as the ceramic insulators can become dirty over time.

Sensitivity

Depending on the application, sensitivity is affected by the introduction of H₂ carrier gas, especially when using existing MS sources like the extractor source. Users tend to see decreased signal-to-noise ratios (S/N) and potentially reduced linear ranges for calibration or higher limits of detection (LOD) due to higher background caused by hydrogen interactions. With the Hydrolnert source for select applications, we have observed increased S/N values or abundance for compounds compared to the extractor source. For example, volatile organic compounds (VOCs) were tested in water samples using

an Agilent 7697A headspace sampler, 8890 GC, and 5977 Inert Plus GC/MSD to compare sensitivity and S/N for the extractor source and Hydrolnert source with H₂ carrier gas. For two example compounds, bromoform and carbon tetrachloride, increases in abundance and S/N are observed in Figure 6. In the same analysis, 1,4-dioxane exhibited increased abundance with the Hydrolnert source, but similar S/N to the extractor source results (Figure 7). Not every compound, matrix, nor analysis will have the same or improved results, and should be tested in a limited capacity before transferring multiple instruments to hydrogen.

To probe the sensitivity of the Hydrolnert source with H₂ carrier gas, octafluoronaphthalene (OFN) at 10 fg/μL (part number 5190-0585) was procured for GC/MS/MS sensitivity testing. For the tandem quadrupole GC/MS/MS system, 4 fg is the maximum allowable instrument detection limit (IDL), and values at 4.0 fg or lower are considered a pass. Four data sets of 12 OFN injections were completed to evaluate the IDL of the Hydrolnert source with H₂ carrier gas installed in an 8890 GC and 7000E triple quadrupole GC/MS system. The four IDL values were 2.1, 4.0, 2.0, and 3.5 fg for an average of 2.9 fg IDL, all of which pass the criteria.

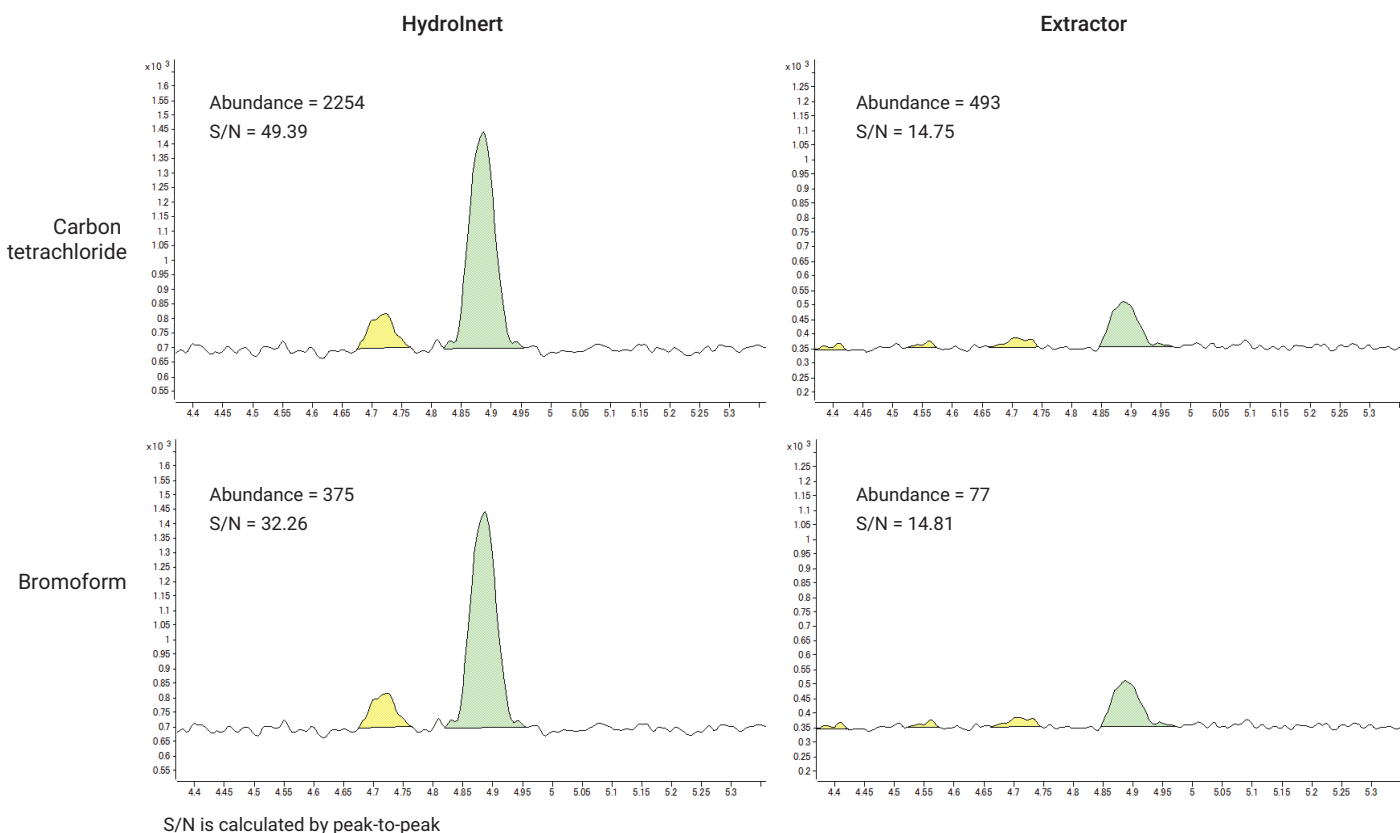

Figure 6. Comparison of the Agilent Hydrolnert source and extractor source EICs for carbon tetrachloride and bromoform when using hydrogen carrier gas with a focus on abundance and S/N.

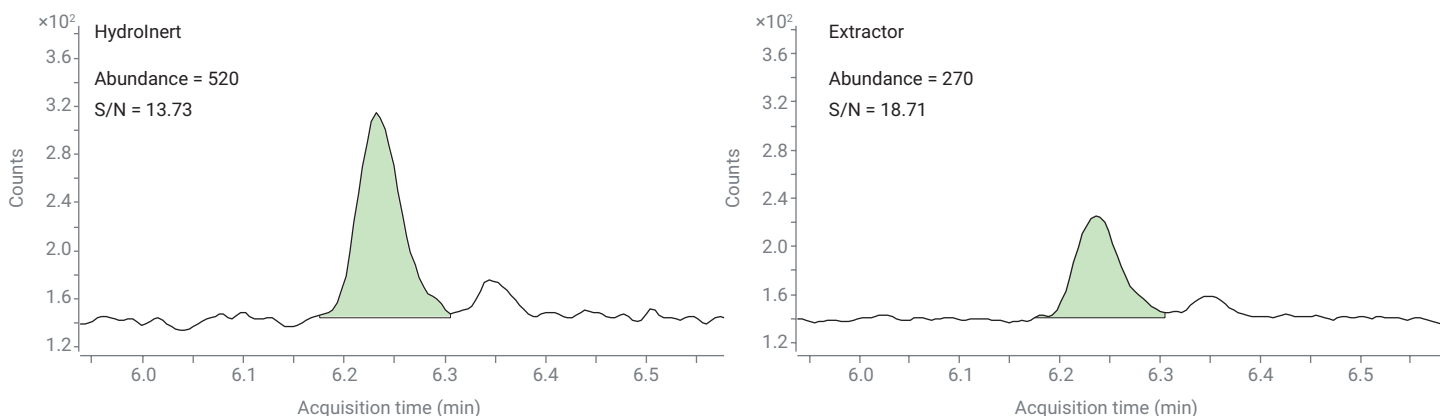

Figure 7. Comparison of the Agilent Hydrolnert source and extractor source EICs for 1,4-dioxane when using hydrogen carrier gas with a focus on abundance and S/N.

Tested applications

A set of applications was selected to evaluate the Hydrolnert source with H₂ GC/MS and GC/MS/MS analyses. The following sections highlight the results of using H₂ carrier gas and the Hydrolnert source for SVOC analysis, pesticide analysis, PAHs, and others. Based on the testing, Table 3 was generated to summarize

the performance of a Hydrolnert Inert Plus system compared to the normal Inert Plus system when using H₂ carrier gas. Results were identified as "unacceptable" if the mass spectra had changes in ion fragment distribution, and misidentification of compounds due to breakdown, hydrogenation, or dechlorination. Some applications have comparable results with respect to mass spectral fidelity between the "normal"

GC/MS system and Hydrolnert system using the respective 9 mm extraction lenses, such as hydrocarbon and PAH analyses, and were identified as "neutral" applications. Applications were identified to have "differentiating" results when the Hydrolnert source (in the presence of H₂ carrier gas) retained mass spectral fidelity and compounds were identified correctly with a helium library as reference.

Table 3. Tested compound classes, including example compounds, with performance abilities for hydrogen carrier gas with a typical Inert Plus source and the Agilent Hydrolnert source.

Compound Class	Example Compound(s)	H ₂ Carrier Gas + Normal GC/MS Source	H ₂ Carrier Gas + Hydrolnert Source
Nitro Compounds	Nitrobenzene, fenitrothion, ethalfuralin	Unacceptable	Differentiating
Heavily Chlorinated Compounds	DDT, Endrin, heptachlor, BHC compounds, pentachlorophenol	Unacceptable	Differentiating
PAHs	Benzo(b)fluoranthene, benzo[g,h,i]perylene, fluoranthene	Neutral	Neutral
Alkanes >C ₂₄	Tetracosane (C ₂₄), octatriacontane (C ₃₈)	Neutral	Neutral
Pesticides	Deltamethrin, fipronil, permethrin, captan	Unacceptable	Differentiating
Fragrance/Flavor Compounds	Musk ketone, musk ambrette, linalool	Unacceptable	Differentiating
VOCs	1,4-dioxane, trichloromethane, bromodichloromethane	Neutral	Differentiating

- "Unacceptable" was declared when mass spectral infidelity or compound misidentification was observed.
- "Neutral" was determined when results were similar across the normal GC/MS system and Hydrolnert source in the presence of hydrogen carrier gas.
- "Differentiating" was stated when the Hydrolnert source retained mass spectral fidelity and compounds were identified correctly with a helium library as reference.

Hydrocarbons

A hydrocarbon "ladder" from *n*-decane (C₁₀) to *n*-octatriacontane (C₃₈) can be used to evaluate cold spots and activity in a GC/MS system, where the high molecular weight compounds will have poor peak shape and significant tailing (>2.0), especially when using H₂ carrier gas. Specifically, for comparison of existing extractor source to the Hydrolnert source, the tailing factor of each straight-chain hydrocarbon peak was reviewed to verify that the Hydrolnert source did not exhibit a worse peak shape. The Hydrolnert TIC is displayed in Figure 8A and the existing extractor source TIC for the hydrocarbons is shown in Figure 8B. TIC comparison shows significant peak tailing for the extractor source with H₂ carrier gas starting at C₂₂ (tailing factor of 1.27), increasing to a tailing factor of 2.1 for C₂₆, and continuing to increase up to extreme tailing with C₃₈ (tailing factor of 10.2). Meanwhile, the TIC for Hydrolnert source data shows improved peak shape with tailing factors ranging between 0.6 to 0.9, where ideal tailing factor is 1.0. The improved peak shape with Hydrolnert source and H₂ carrier gas indicates thermal stability and lessened activity in the mass spectrometer, compared to the existing extractor source with H₂ carrier gas.

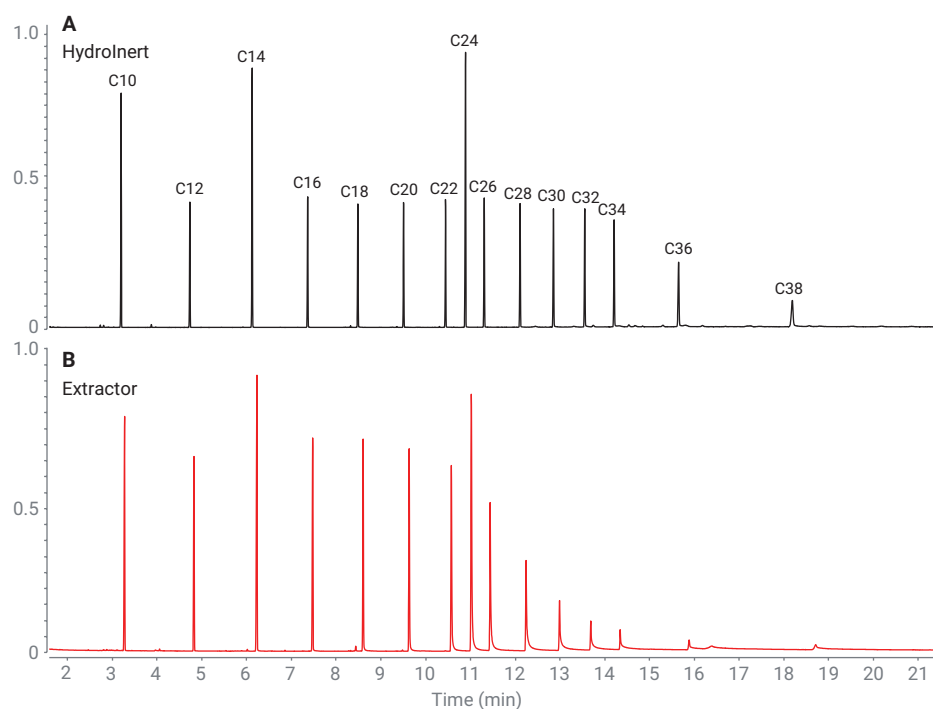

Figure 8. TICs of straight-chain hydrocarbons from *n*-decane (C₁₀) to *n*-octatriacontane (C₃₈) to visually represent the observed tailing (or lack thereof) when using hydrogen carrier gas with the (A) Agilent Hydrolnert source and (B) existing extractor source.

Semivolatile compounds analysis: EPA 8270 and PAHs

The United States EPA method 8270 (versions 8270D and 8270E) contains a list of over 200 compounds suitable for analysis by GC/MS in solid waste, soil, air, and water extracts.^{3,4} Method 8270 contains SVOCs across several analyte class types from acids, bases, neutral compounds, and PAHs; to understand the application range and limit of the Hydrolnert source EPA 8270 analytes were tested, due to the wide range of compound classes and application uses in laboratories. The screening mixture in Table 2 is comprised of many semivolatile compounds that are found in the EPA method 8270 list, which shows the retention of expected mass spectral fragments with high LMSs when compared to a helium sourced library, such as NIST. Additionally, Figure 10

compares the extractor source (top) and Hydrolnert source (bottom) for a mixture of 68 SVOCs and PAHs when using H₂ carrier gas and shows excellent peak shape and improved peak shape for the Hydrolnert source compared to the extractor source.

A critical component of EPA 8270 is the tune criteria associated with the ion ratios of decafluorotriphenylphosphine (DFTPP). EPA method 8270 has been tested on the GC/MS/MS system, where the etune algorithm is used as the recommended tune (this has been noted in a previous application note).⁵ For the GC/MS single quadrupole system, the DFTPP ion ratio criteria from Table 3 of EPA method 8270E and EPA method 8270D were used to test the Hydrolnert source with H₂ carrier gas.^{3,4} EPA method 8270D includes more ion ratio criteria than EPA 8270E, which reflects the EPA 525 criteria table. Table 4 summarizes the relative abundances of the DFTPP ion ratios at 25 ng/μL, the method criteria,

and if the measured relative abundances matched the criteria, where all measured relative abundances pass both the 8270E and 8270D ion ratio criteria.

There is always concern about sensitivity and maintenance of response factors (RFs) for both single quadrupole and triple quadrupole systems when moving an analysis from helium to hydrogen carrier gas. Table 5 lists the RFs from EPA method 8270E Table 4 (guidance criteria), RFs from a GC/MS analysis with helium carrier gas, RFs for GC/MS analysis with Hydrolnert source and hydrogen carrier gas, and RFs for GC/MS/MS analysis with Hydrolnert source and hydrogen carrier gas. All test systems used 9 mm extraction lenses, respective of the source type (for example, the Hydrolnert source had a Hydrolnert 9 mm extraction lens). The RFs from EPA method 8270E Table 4 are guidance criteria and not requirements to pass the method, but ideally the RFs should be similar to these guidance values. For the He GC/MS analysis, two compounds have RFs below the guidance criteria: hexachloroethane and N-nitroso-di-n-propylamine. For the H₂ Hydrolnert GC/MS analysis, five additional compounds have RFs below the guidance criteria, where four are within 0.1 points. For example, the guidance RF criteria for bis(2-chloroethyl) ether is 0.7 and the H₂ Hydrolnert GC/MS RF was 0.6. For the H₂ Hydrolnert GC/MS/MS analysis, there were 15 more compounds with RF values lower than the He GC/MS system, but the GC/MS/MS also opens the potential to analyze lower concentration levels down to 20 pg/μL, when the normal calibration range is 100 pg/μL to 100 ng/μL. In regards to sensitivity, 96 compounds were analyzed in a previous application for EPA 8270 with He carrier gas on GC/MS.⁶ Comparing these compounds with the same set using the Hydrolnert source and H₂ carrier (also GC/MS), only five compounds had a smaller

Table 4. DFTPP ions, abundance criteria from EPA method 8270D and 8270E^{3,4}, measured relative abundance, and pass/fail of the relative abundance.

Target Mass (m/z)	Ion Abundance Criteria	Measured Relative Abundance	Pass/Fail
51	*10 to 80% of 198 m/z	11.4%	Pass
68	<2% of 69 m/z	1.7%	Pass
69	Present	27.2%	Pass
70	<2% of 69 m/z	1.0%	Pass
127	*10 to 80% of 198 m/z	31.1%	Pass
197	<2% of 198 m/z	0.1%	Pass
198	Base peak or present *or >50% of 442 m/z	73.7%	Pass
199	5 to 9% of 198 m/z	7.4%	Pass
275	10 to 60% of base peak	29.2%	Pass
365	>1% of base peak	3.5%	Pass
441	<150% of 443 m/z *present, but <24% of 442	86.4% *16.7%	Pass
442	Base peak or present *or >50% of 198 m/z	100% (base peak)	Pass
443	15 to 24% of 442 m/z	23.4%	Pass

* Denotes EPA method 8270D requirement difference from EPA method 8270E requirement.

Table 5. Response Factors (RFs) for select compounds from EPA method 8270E (Table 4 in the EPA method)⁴, GC/MS single quadrupole analysis with He carrier gas, GC/MS single quadrupole analysis with Agilent Hydrolnert source and H₂ carrier gas, and GC/MS/MS tandem quadrupole analysis with Hydrolnert source and H₂ carrier gas.

Compound	Response Factor (RF) from EPA Method 8270E ⁴	RF He GC/MS	RF H ₂ Hydrolnert GC/MS	RF H ₂ Hydrolnert GC/MS/MS
Acenaphthene	0.9	1.3	1.1	0.2
Acenaphthylene	0.9	1.9	1.4	0.1
Acetophenone	0.01	1.2	0.4	1.0
Anthracene	0.7	1.1	1.0	0.9
Benzo(a)anthracene	0.8	1.4	1.5	1.0
Benzo(a)pyrene	0.7	1.2	0.9	0.9
Benzo(b)fluoranthene	0.7	1.4	1.2	1.2
Benzo(g,h,i)perylene	0.5	1.1	1.0	1.3
Benzo(k)fluoranthene	0.7	1.2	1.2	1.3
Bis(2-chloroethoxy)methane	0.3	0.4	0.3	0.7
Bis(2-chloroethyl)ether	0.7	0.8	0.6	0.5
Bis-(2-ethylhexyl)phthalate	0.01	0.8	0.5	0.2
4-Bromophenyl-phenyl ether	0.1	0.3	0.2	0.2
Butyl benzyl phthalate	0.01	0.6	0.3	0.1
4-Chloroaniline	0.01	0.4	0.4	0.6
4-Chloro-3-methylphenol	0.2	0.3	0.2	0.4
2-Chloronaphthalene	0.8	2.4	1.0	0.8
2-Chlorophenol	0.8	0.8	0.7	0.5
4-Chlorophenyl-phenyl ether	0.4	0.7	0.5	0.3
Chrysene	0.7	1.2	1.1	0.4
Dibenz(a,h)anthracene	0.4	1.1	1.0	0.2
Dibenzofuran	0.8	1.7	1.5	1.4

linear range: hexachlorobutadiene, 2,6-dinitrotoluene, diethyl phthalate, 2,4-dinitrotoluene, and pentachlorophenol, where the first three were smaller by one concentration level, starting at 200 pg/μL instead of 100 pg/μL, and 2,4-dinitrotoluene calibration range was 0.1 to 75 ng/μL for the H₂ HydroInert analysis. The pentachlorophenol concentration range starts at 500 pg/μL with H₂ HydroInert GC/MS analysis, instead of 100 pg/μL. For benzoic acid, HydroInert with H₂ carrier gas exhibited the same calibration range from 0.8 to 100 ng/μL, as He carrier gas. H₂ carrier gas with the HydroInert source retains the sensitivity, for most of the semivolatile compounds tested are normally observed with He carrier gas.

Compound	Response Factor (RF) from EPA Method 8270E ⁴	RF He GC/MS	RF H ₂ HydroInert GC/MS	RF H ₂ HydroInert GC/MS/MS
Di- <i>n</i> -butyl phthalate	0.01	1.3	0.8	0.8
3,3'-Dichlorobenzidine	0.01	0.5	0.4	0.1
2,4-Dichlorophenol	0.2	0.3	0.2	0.4
Diethyl phthalate	0.01	1.4	1.0	0.6
Dimethyl phthalate	0.01	1.4	1.0	0.8
2,4-Dimethylphenol	0.2	0.3	0.3	0.4
4,6-Dinitro-2-methylphenol	0.01	0.2	0.1	0.01
2,4-Dinitrophenol	0.01	0.2	0.1	0.02
2,4-Dinitrotoluene	0.2	0.4	0.2	0.03
2,6-Dinitrotoluene	0.2	0.3	0.2	0.03
Di- <i>n</i> -octyl phthalate	0.01	1.3	0.8	0.4
Fluoranthene	0.6	1.2	1.2	0.4
Fluorene	0.9	1.3	1.2	1.4
Hexachlorobenzene	0.1	0.3	0.3	0.4
Hexachlorobutadiene	0.01	0.2	0.2	0.4
Hexachlorocyclopentadiene	0.05	0.3	0.1	0.03
Hexachloroethane	0.3	0.2	0.1	0.14
Indeno(1,2,3- <i>cd</i>)pyrene	0.5	1.2	1.2	1.0
Isophorone	0.4	0.6	0.4	0.3
2-Methylnaphthalene	0.4	0.7	0.7	1.7
2-Methylphenol	0.7	0.7	0.6	0.5
4-Methylphenol	0.6	1.0	0.3	0.7
Naphthalene	0.7	1.1	1	0.9
2-Nitroaniline	0.01	0.4	0.23	0.05
3-Nitroaniline	0.01	0.3	0.18	0.03
4-Nitroaniline	0.01	0.3	0.21	0.13
Nitrobenzene	0.2	0.3	0.2	0.3
2-Nitrophenol	0.1	0.2	0.11	0.1
4-Nitrophenol	0.01	0.2	0.14	0.05
N-Nitroso-di- <i>n</i> -propylamine	0.5	0.4	0.4	0.03
N-Nitrosodiphenylamine	0.01	2.05	0.9	2.3
2,2'-Oxybis-(1-chloropropane)	0.01	0.45	0.54	0.03
Pentachlorophenol	0.05	0.18	0.1	0.1
Phenanthrene	0.7	1.2	1.1	1.1
Phenol	0.8	0.9	0.7	0.3
Pyrene	0.6	1.3	1.2	0.4
1,2,4,5-Tetrachlorobenzene	0.01	0.38	0.31	0.23
2,3,4,6-Tetrachlorophenol	0.01	0.36	0.17	0.07
2,4,5-Trichlorophenol	0.2	0.3	0.3	0.2
2,4,6-Trichlorophenol	0.2	0.3	0.2	0.2

As another example of the linear range retention, Figure 9 compares the linear range for nitrobenzene in He carrier gas (Figure 9A, top) and in H₂ carrier gas with HydroInert source (Figure 9B, bottom). The average RF RSD percentages are remarkably similar between the He and H₂ + HydroInert source results at 6.33% RSD for He and 6.59% RSD for H₂ carrier gas and HydroInert source.

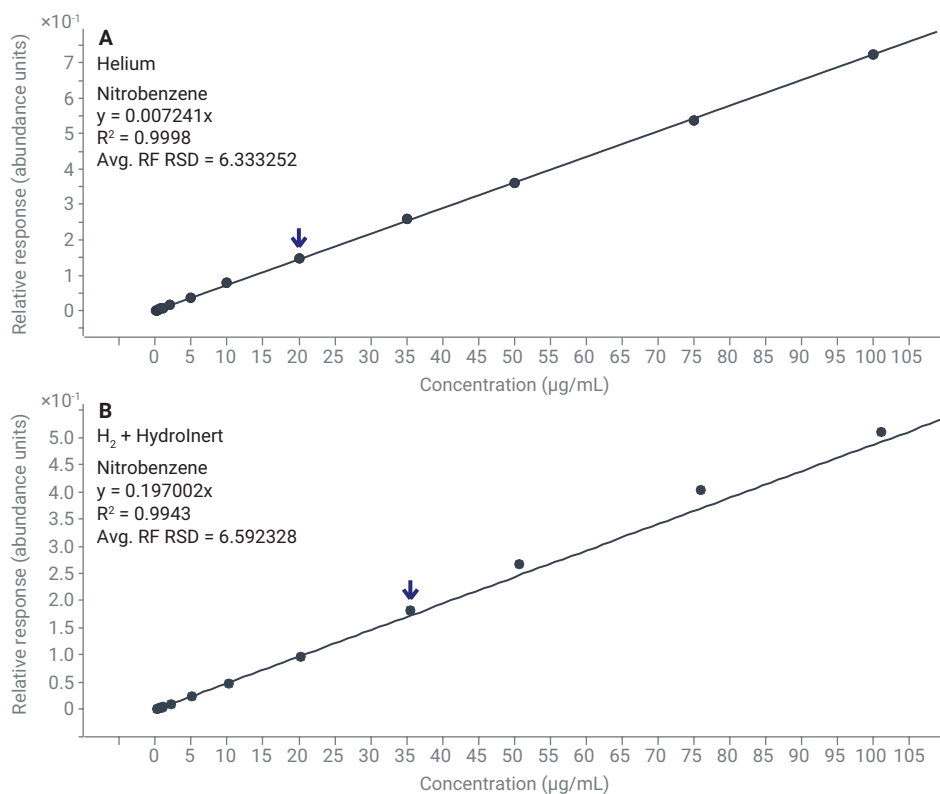

Figure 9. Nitrobenzene linear range (0.1 to 100 ng/µL) collected on a GC/MS system in (A) He and (B) H₂ carrier gas, with Agilent HydroInert source.

PAHs are a compound class that has been transitioned to H₂ analysis by GC/MS and GC/MS/MS, as they are very stable aromatic hydrocarbons.⁷ They have also been tested with the Hydrolnert source. In using the Hydrolnert source with H₂ carrier gas, improved peak shape and resolution was observed when compared to an extractor source under the same method and carrier gas conditions, as shown in Figures 10 and 11. This was most visible with the later-eluting PAHs, such as benzo(b)fluoranthene, benzo(k) fluoranthene, and benzo(g,h,i)perylene (Figure 11).

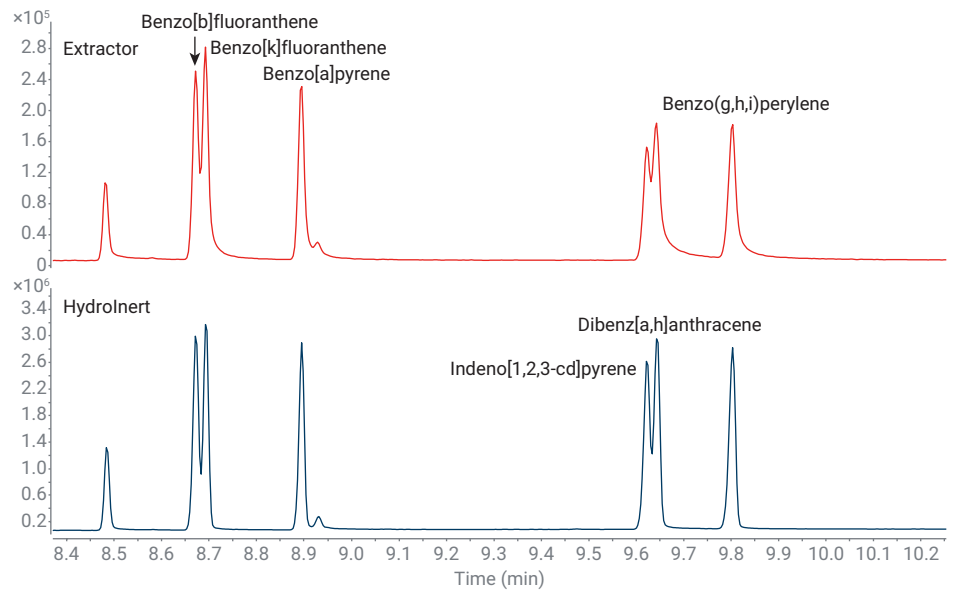

Figure 11. Zoom in of later-eluting PAH region to compare peak shape and resolution of these compounds when using H₂ carrier gas with an extractor source and Agilent Hydrolnert source at 50 ng/μL.

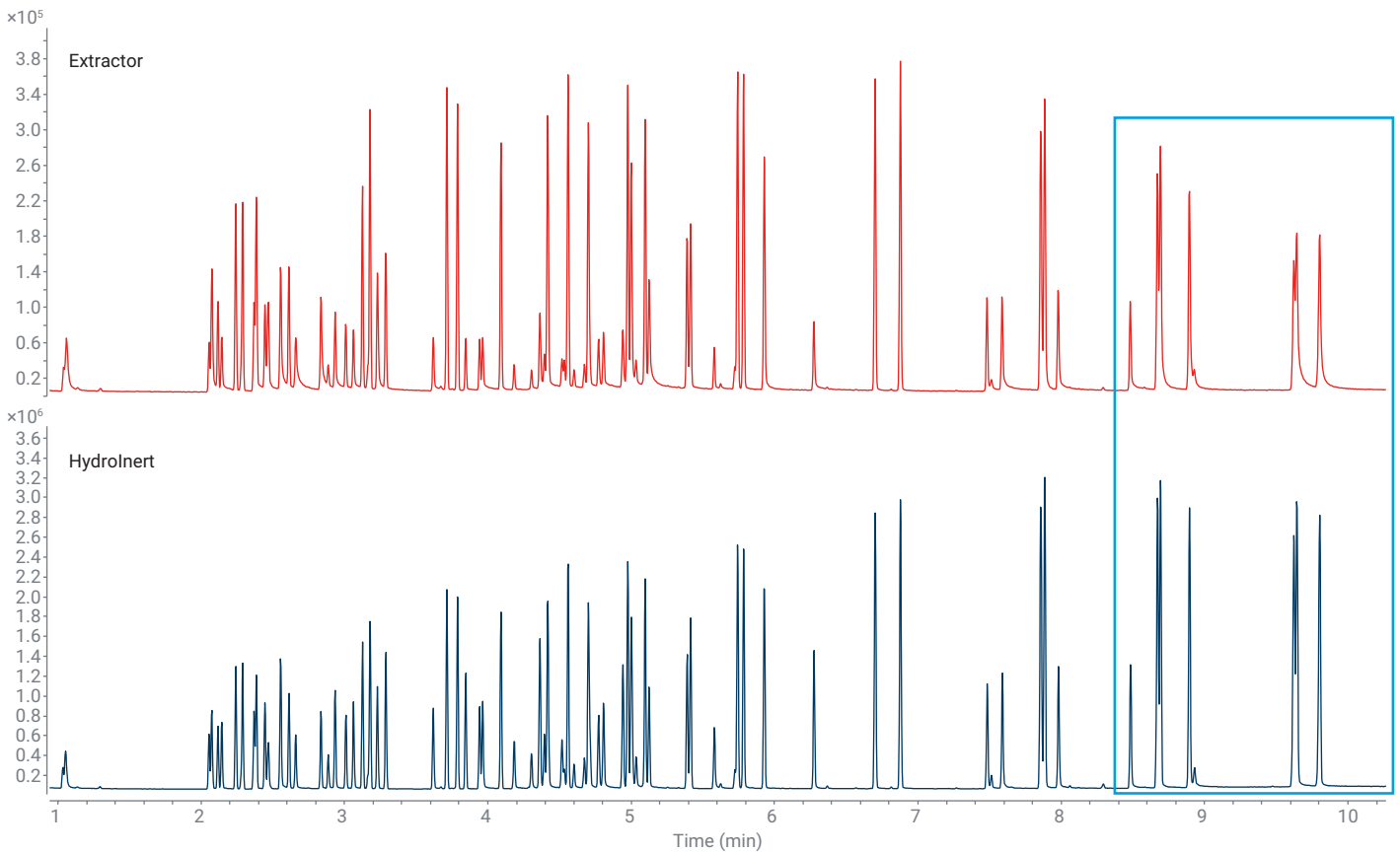

Figure 10. Comparison of peak shape and resolution for H₂ carrier gas with an extractor source and Agilent Hydrolnert source for a set of 68 target analytes for EPA method 8270 at 50 ng/μL.

Pesticide analysis

For pesticide analysis, a midcolumn backflush setup in an 8890 GC and 7000E triple quadrupole GC/MS was configured with two HP-5ms Ultra Inert GC columns 20 m × 0.18 mm, 0.18 μm, connected through an Agilent purged Ultimate union (PUU), H₂ carrier gas, and HydroInert source. This column set with H₂ carrier gas allowed the usage of the Agilent pesticide and environmental pollutants (P&EP) multiple reaction monitoring (MRM) database for retention times and MRM transitions, which was originally collected on a 15 × 15 m (0.25 mm × 0.25 μm) HP-5ms Ultra Inert GC column design with He carrier gas. The 20 × 20 m setup was retention-time locked. Multiple sets of pesticide standards were tested to evaluate the mass spectra of various compound classes commonly observed in pesticide analysis, like nitro compounds and heavily chlorinated compounds. Example pesticides from these mixtures include deltamethrin, ethalfluralin, fipronil, cyfluthrin, permethrin, captan, parathion, endrin, and heptachlor. The pesticide mixtures were tested with H₂ carrier gas using an Inert Plus source with a 3 mm extraction lens, the recommended lens for trace pesticide analysis in He, and using a HydroInert source with a 9 mm extraction lens. The first round of testing used scan mode for acquisition to understand if the fragmentation profiles were retained for various pesticides with H₂ carrier gas, if ion abundances changes, or new hydrogenation product ions were identified in both source cases. Ethalfluralin contains two nitro groups and a change in the most abundant ions are viewed best when overlaying the top five EICs; the comparison of sources is shown in Figure 12. The five highest abundance ions for ethalfluralin, from helium collected mass spectrum, are 55, 276, 56, 316, and 292 *m/z*. If the nitro groups become hydrogenated in the

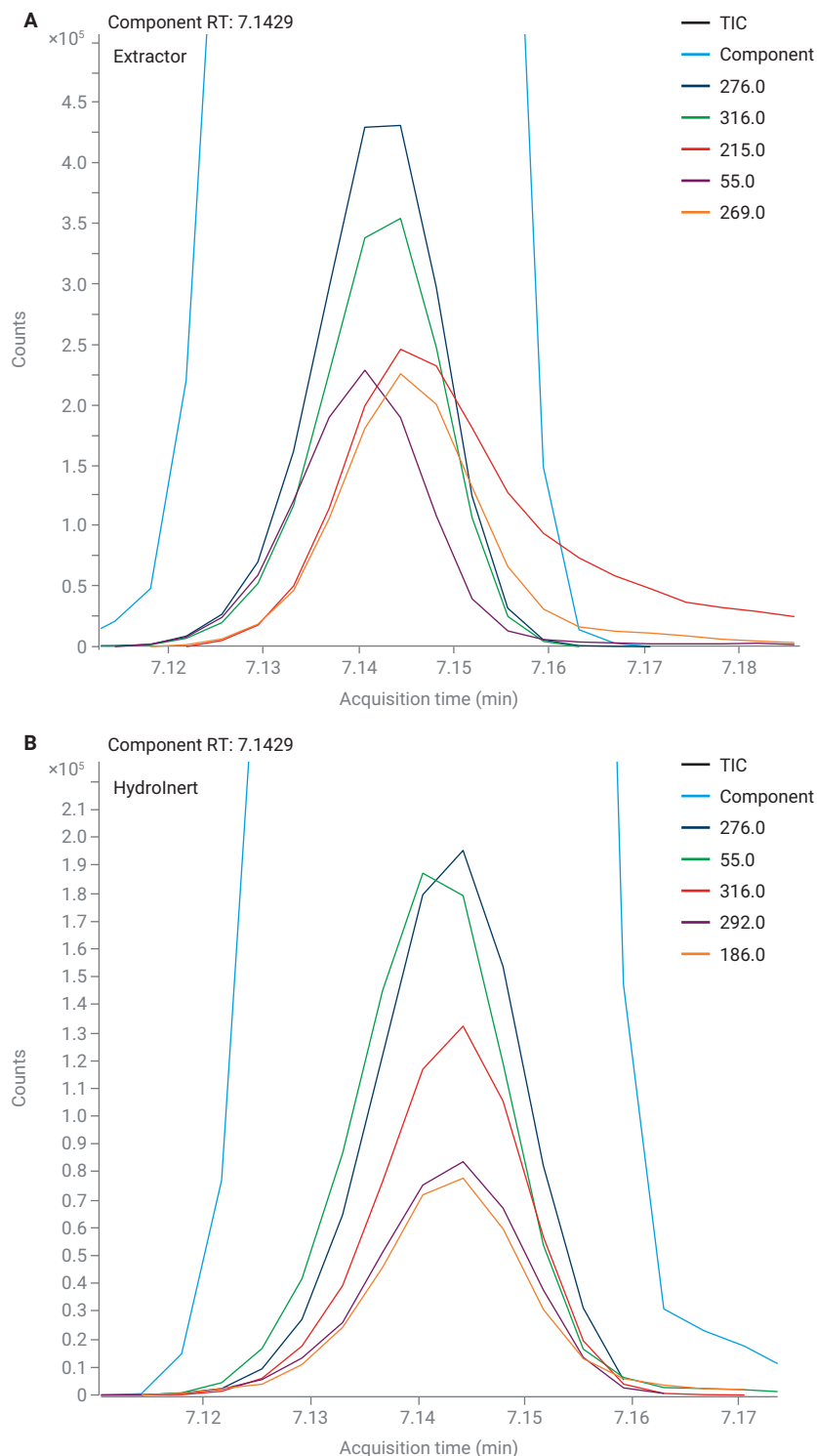

Figure 12. EICs of the top five abundant ions for ethalfluralin with H₂ carrier gas and (A) extractor source with 3 mm extraction lens and (B) Agilent HydroInert source with 9 mm extraction lens.

source, the mass spectrum would have a significant contribution of 269 m/z , which is not a significant ion in the reference He mass spectrum. For H₂ carrier gas with extractor source (Inert Plus), Figure 12A shows the top five abundant ions, which include 269 and 215 m/z , and indicate hydrogenation in the source; there is also rearrangement in the most abundant ions, where 55 m/z is suppressed to the fourth most abundant with an increase in 316 m/z ranking and inclusion of 215 m/z , which is a small contribution in the normal He spectra. Comparatively, Figure 12B of the same experiment with the HydroInert source has no 269 m/z in the top five abundant ions, indicating no hydrogenation. Retention of expected ion abundance with the HydroInert source in presence of

H₂ allows method developers to use the same MRM transitions or selected ion monitoring (SIM) ions and would require less time in a transition to hydrogen carrier gas.

Another example of differences between the extractor source and HydroInert source with H₂ carrier gas is observed with deltamethrin. Deltamethrin is one of the pesticide compounds with a cyano(4-phenoxyphenyl)methyl-2,2-dimethylcyclopropanecarboxylate structure; compounds in this class have different functional groups after the cyclopropane structure. These compounds also share a cleavage point at the C–O bond of the ester group with a major fragment associated with 209 m/z , an *m*-phenoxyphenylacetonitrile structure. This 209 m/z fragment

typically appears in deltamethrin mass spectrum, but at lower abundance. The deltamethrin results from scan acquisition were reviewed in MassHunter Unknowns Analysis software, and in some cases, deltamethrin was not identified at the typical retention time of 18.17 minutes with the extractor source. Instead, *m*-phenoxyphenylacetonitrile was identified, as shown in Figure 13A, with a large abundance of 209 m/z and no ion abundance at 253 m/z . In some other runs with the extractor source, deltamethrin was identified (Figure 13B), but with LMSs in the 70s range and large abundance of 209 m/z . In Figure 13C, deltamethrin was identified with LMS values between 91 and 94 and the deconvoluted mass spectrum is remarkably similar to the (He) NIST library spectrum on the bottom.

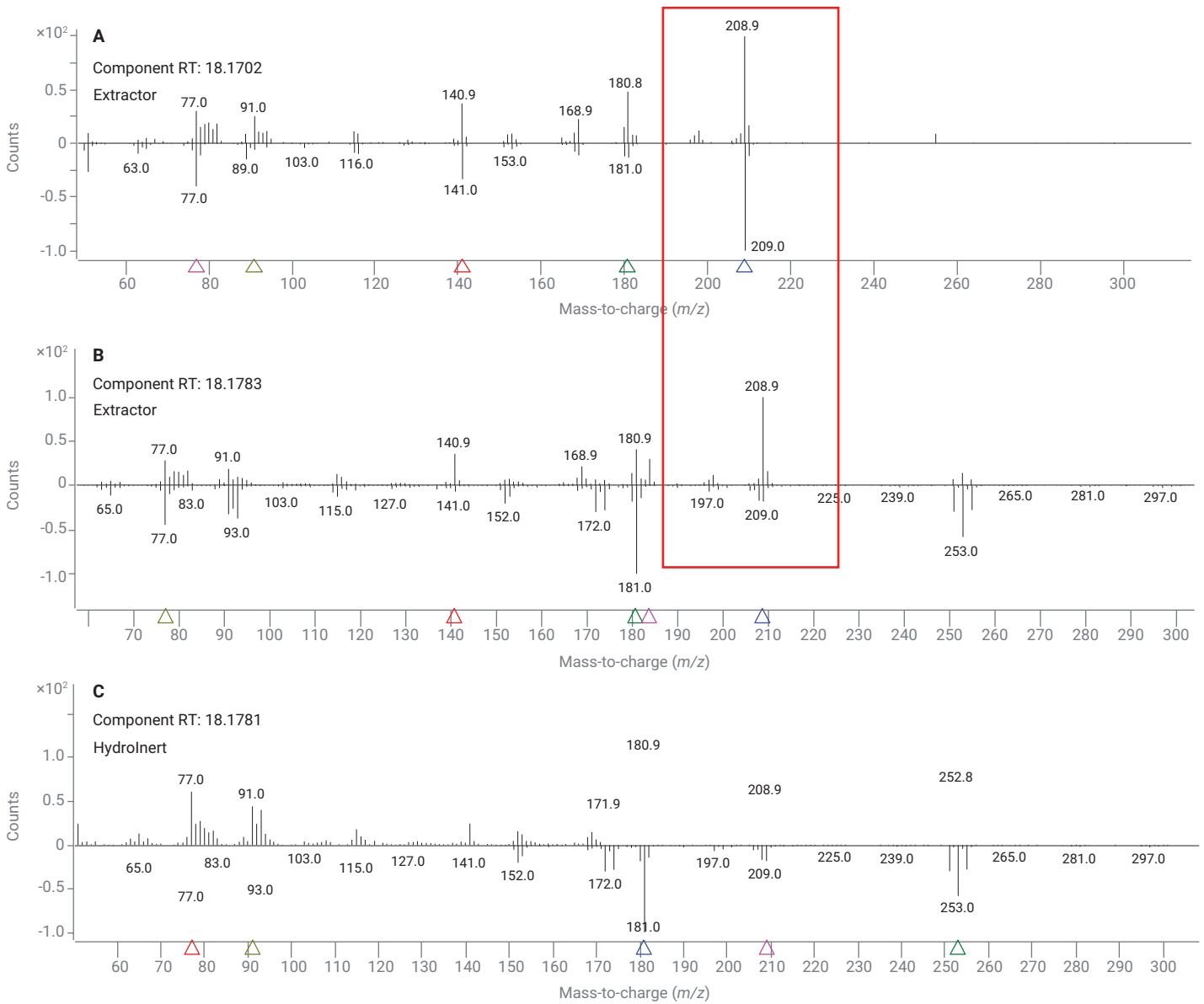

Figure 13. Head-to-tail comparison of deconvoluted mass spectrum (top of each subfigure) to library mass spectrum, NIST17.L (bottom of each subfigure) for deltamethrin with H₂ carrier gas and (A) extractor source with 3 mm extraction lens run 1, (B) extractor source with 3 mm extraction lens run 2, and (C) Agilent Hydrolnert source with 9 mm extraction lens.

Volatile organic compounds (VOCs)

For VOCs, a 6 mm HydroInert extraction lens is recommended, but a 9 mm HydroInert extraction lens may also be an option. A method was developed for rapid identification and quantification of volatiles at low $\mu\text{g/L}$ levels in water samples. The combination of the Agilent 8697 headspace sampler, 8890 GC, and 5977C GC/MSD, when using H_2 carrier gas and the new HydroInert EI source, provides this capability for many volatiles in water.

The headspace approach often provides a simpler alternative to purge and trap sampling, if local regulations allow it. The data in Figure 14 was run in scan mode for broad screening with spectral confirmation, as it is possible to measure lower levels with SIM acquisition of selected targets. The identification of the four trihalomethanes with their expected most abundant ions displays the ability of the HydroInert source to prevent dehalogenation in the presence of H_2 carrier gas. Additionally, Table 6 tabulates the LMSs from comparing the deconvoluted spectra to the NIST library.

The match scores of 80 and higher indicate excellent retention of the normal fragmentation pattern in H_2 carrier gas with the HydroInert source, when compared to NIST library mass spectra, which were collected with He.

Table 6. NIST helium library scores for select low-level ($\mu\text{g/L}$) trihalomethanes analyzed with H_2 carrier gas and the Agilent HydroInert source.

	Retention Time (minutes)	NIST LMS
Trichloromethane	2.107	93
Bromodichloromethane	2.792	86
Dibromochloromethane	3.526	88
Tribromomethane	4.267	80

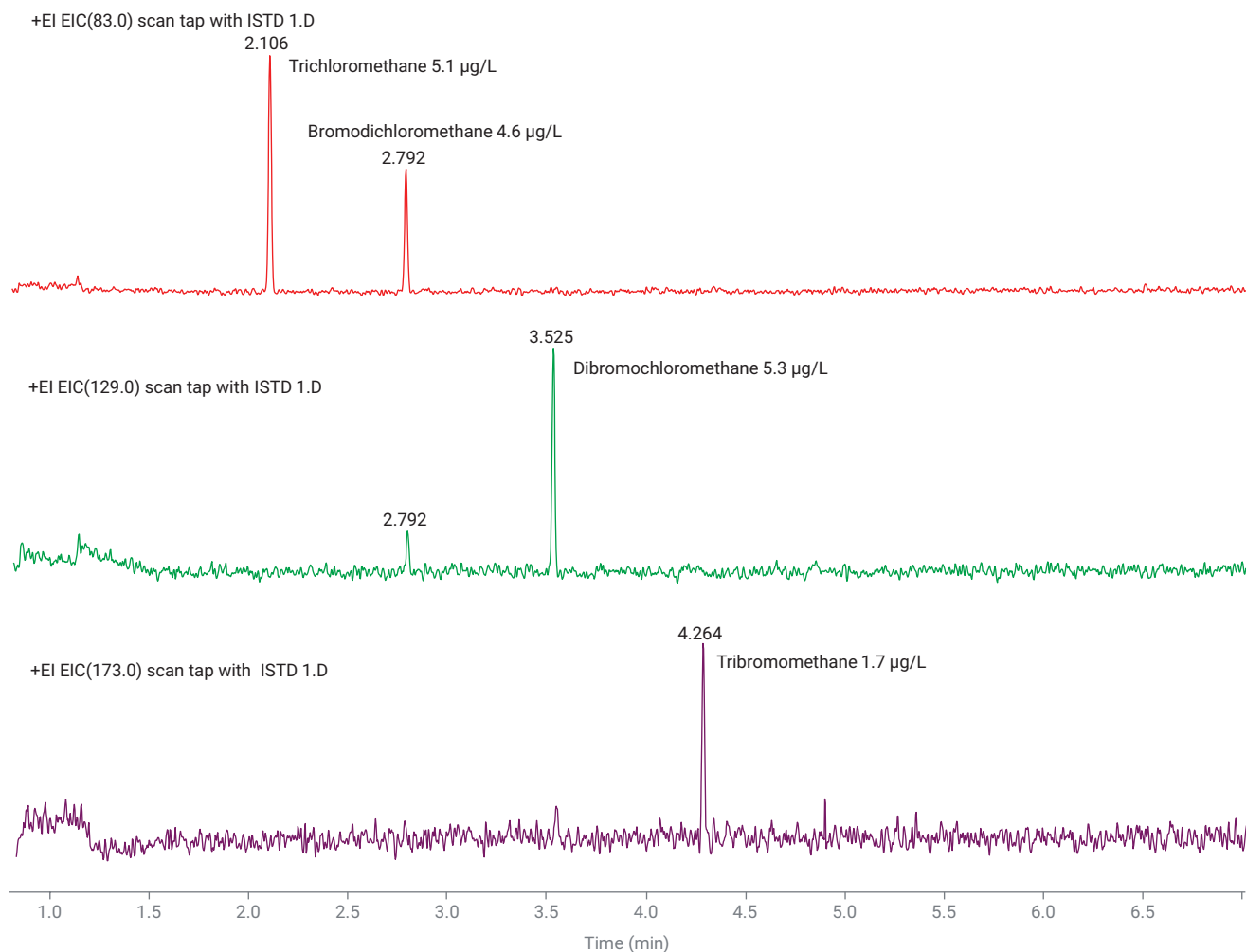

Figure 14. Extracted ion chromatograms (EICs) of 83, 129, and 173 m/z with identification and quantification of four trihalomethanes when running a headspace HS/GC/MS system with H_2 carrier gas and the Agilent HydroInert source.

HydroInert upgrade kits and complete source assembly

Figure 15 is a broken-out parts diagram of an assembled HydroInert source, with the HydroInert-specific parts highlighted in a purple color (parts 17, 12, 3, 4, 10, and 9, if looking from left to right of the figure). Additionally, item number 16, source heater block assembly, is specialized for the HydroInert source with "H₂" etched into the face to indicate that the HydroInert source, which is compatible with H₂ carrier gas, is currently installed into a mass spectrometer. All other parts in the diagram are the same as found in an Inert Plus (or extractor) source. Table 7 contains the parts associated with each number in Figure 15. Parts 11, 13, 14, and 15 are inserted into the front of the heater block and not shown individually in this figure.

HydroInert complete source assembly (part number G7078-67930) and HydroInert GC/MSD upgrade kit (part number 5505-0083) for the existing Agilent 5977A extractor GC/MSD and Agilent 5977B Inert Plus GC/MSD are available. The fully assembled source is ready to install into the mass spectrometer without having to change out parts of an existing source, which would be required with the HydroInert GC/MSD upgrade kit. All the parts listed in Table 8 are included in the HydroInert GC/MSD upgrade kit. The HydroInert source is not compatible with older mass spectrometer models, such as the Agilent 5975 Series GC/MSD, nor with stainless steel or inert sources.

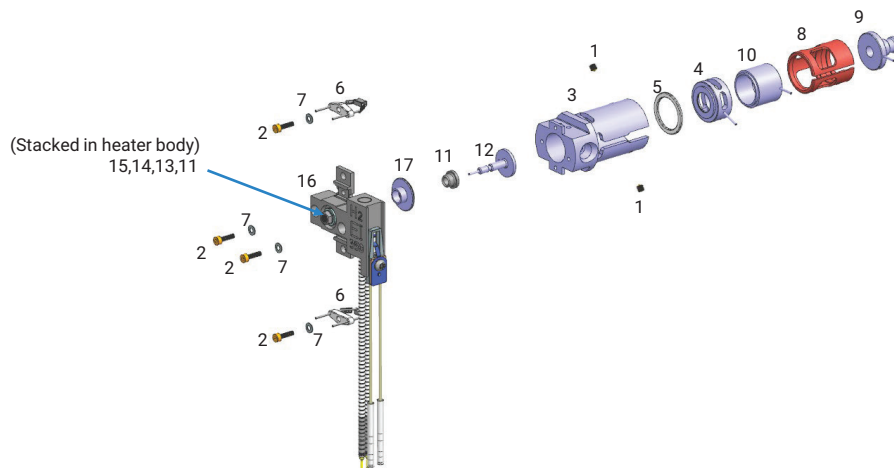

Figure 15. Broken-out parts of an assembled Agilent HydroInert source.

Table 7. List of parts in a fully assembled Agilent HydroInert source for an Agilent Inert Plus GC/MS system.

Item Number (Figure 15)	Part Name	Part Number
1	Setscrews	G3870-20446
2	Screws	G3870-20021
3	Extractor source body*	G7078-20903
4	Extractor lens-9 mm*	G7078-20909
5	Extractor lens insulator	G3870-20445
6	Filament	G7005-60061
7	Spring washer Flat washer	3050-1301 3050-0982
8	Lens insulator	G3870-20530
9	Entrance lens*	G7078-20904
10	Ion focus lens*	G7078-20905
11	Repeller insulator	G1099-20133
12	Repeller*	G7078-20902
13	Flat washer	3050-0891
14	Belleville spring washer	3050-1301
15	Repeller nut	0535-0071
16	H ₂ EI heater/sensor assembly*	G7078-67910
17	Insert*	G7078-20901

* HydroInert-specific parts.

The Hydrolnert complete source assembly (part number G7006-67930) and Hydrolnert triple quadrupole GC/MS upgrade kit (part number 5505-0084) for the existing Agilent 7000C/D triple quadrupole GC/MS systems are available. All the parts listed in Table 9 are included in the Hydrolnert triple quadrupole GC/MS upgrade kit. If a user already has a 7000C or 7000D Inert Plus triple quadrupole GC/MS, a Hydrolnert triple quadrupole GC/MS upgrade kit could be purchased that includes the Hydrolnert mass spectrometer parts indicated in Figure 15, except the entrance lens is an extended entrance lens, which is designed specifically for the tandem quadrupole systems.

If multiple sources are kept in the laboratory, the Hydrolnert parts should be stored separately from other sources and kept with the H₂ heater/sensor assembly for easy identification that an H₂-compatible (Hydrolnert) source is installed in the MS system. Additionally, the triple quadrupole parts should be kept separate from the single quadrupole parts as the entrance lenses are different lengths and should not be swapped.

Table 8. Agilent Hydrolnert GC/MSD upgrade kit for the Agilent 5977A extractor GC/MSD, Agilent 5977B Inert Plus GC/MSD or Agilent 5977C GC/MSD) with part numbers and item number indicated in Figure 15.

Item Number (Figure 15)	Part Name	Part Number
NA	Hydrolnert GC/MSD upgrade	5505-0083
17	Insert*	G7078-20901
12	Repeller*	G7078-20902
3	Extractor source body*	G7078-20903
9	Entrance lens*	G7078-20904
10	Ion focus lens*	G7078-20905
4	Extractor lens– 9mm*	G7078-20909
16	H ₂ EI heater/sensor assembly*	G7078-67910
NA	Wire, extractor lens	G7000-60827
11	Repeller insulator (x2)	G1099-20133

* Hydrolnert-specific parts.

Table 9. Agilent Hydrolnert triple quadrupole GC/MS upgrade kit for the Agilent 7000C/D/E triple quadrupole mass spectrometers, with part numbers and item numbers indicated in Figure 15.

Item Number (Figure 15)	Part Name	Part Number
NA	Hydrolnert GC/TQ upgrade	5505-0084
17	Insert*	G7078-20901
12	Repeller*	G7078-20902
3	Extractor source body*	G7078-20903
9**	Entrance lens –extended*. **	G7006-60926
10	Ion focus lens*	G7078-20905
4	Extractor lens–9 mm*	G7078-20909
16	H ₂ EI heater/sensor assembly*	G7078-67920
NA	Wire, extractor lens	G7000-60827
11	Repeller insulator (x2)	G1099-20133

* Hydrolnert-specific parts.

** The extended entrance lens for the Hydrolnert MS/MS system is longer than the entrance lens of a single quadrupole MS system.

Before installing the Hydrolnert ion source, verify that the instrument hardware supports use of this source. The Hydrolnert ion source is supported on:

- 5977 Series GC/MSD Single Quad instrument models 5977A, 5977B, and 5977C
- 7000 Series GC/TQ Triple Quad instrument models 7000C, 7000D, and 7000E

Note: Diffusion pump single quadrupole instruments are not supported. A turbo pump is required.

For systems that are purchased with either the Hydrolnert ion source or Extractor (Inert Plus) ion source installed, all components necessary to use the Hydrolnert are already installed.

For systems sold before the introduction of the Hydrolnert source that are not already using these components, such as 5977 series instruments using a stainless steel or inert ion source, it will be necessary to install these components before using the Hydrolnert ion source.

These components include:

- A transfer line tip seal to electrically isolate the ion source from the transfer line
- Two wires that connect from the ceramic ion source board to the ion source
- A green wire to control the voltage of the ion source body
- A brown wire to control the voltage of the extractor lens

If you need assistance with method development and optimization, the Agilent global team of experts can help with your application needs through the Agilent CrossLab Application Services, in Method and Application Services (part number H2149A; R1736A) or Method Optimization (part number R1736C; R-21H-501).

Conclusion

The Agilent Hydrolnert source with H₂ carrier gas provides a more sustainable alternative to He carrier gas, and helps improve performance of H₂ carrier gas for GC/MS and GC/MS/MS analyses. The novel source comes fully assembled or as part of an upgrade kit for existing GC/MS and GC/MS/MS systems. In terms of performance, the Hydrolnert source retains mass spectral fidelity and allows users to continue using existing helium-based mass spectral libraries.

References

1. Agilent EI GC/MS Instrument Helium to Hydrogen Carrier Gas Conversion, *Agilent Technologies user guide*, publication number 5994-2312EN, **2020**.
2. Quimby, B. *et al.* In-Situ Conditioning in Mass Spectrometer Systems, *US Patent 8,378,293*, February 19, **2013**.
3. Semivolatile Organic Compounds by Gas Chromatography/Mass Spectrometry (GC/MS); Method 8270D. *United States Environmental Protection Agency*, Revision 4, February **2007**.
4. Semivolatile Organic Compounds by Gas Chromatography/Mass Spectrometry (GC/MS); Method 8270E. *United States Environmental Protection Agency*, Revision 4, June **2018**.
5. Churley, M.; Quimby, B.; Andrianova, A. A Fast Method for EPA 8270 in MRM Mode Using the 7000 Series Triple Quadrupole GC/MS, *Agilent Technologies application note*, publication number 5994-0691EN, **2019**.
6. Smith Henry, A. Analysis of Semivolatile Organic Compounds with Agilent Sintered Frit Liner by Gas Chromatography/Mass Spectrometry, *Agilent Technologies application note*, publication number 5994-0953EN, **2019**.
7. Andrianova, A.; Quimby, B. Optimized PAH Analysis Using Triple Quadrupole GC/MS with Hydrogen Carrier, *Agilent Technologies application note*, publication number 5994-2192EN, **2020**.

www.agilent.com

DE97431848

This information is subject to change without notice.

© Agilent Technologies, Inc. 2022
Printed in the USA, November 7, 2022
5994-4889EN